

CURVE DI PORTATA\*FLOW CHARTS  
PRESSIONE D'INGRESSO\*INLET PRESSURE = 1 MPa(10 Bar)

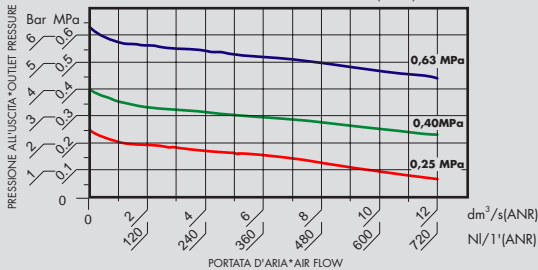

CARATTERISTICHE DI REGOLAZIONE\*REGULATION FEATURES

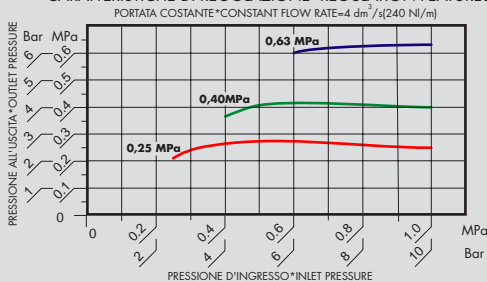

CARATTERISTICHE DEL RELIEVING\*RELIEVING PERFORMANCES

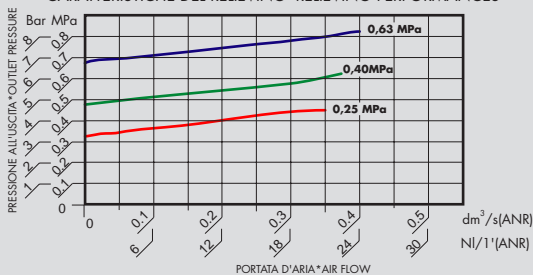

## Microregolatore

Adatto per innumerevoli applicazioni industriali.

- \* Funzionamento a membrana.
- \* Completo di ghiera per il montaggio a pannello.
- \* Possibilità di fissaggio a parete su staffa.
- \* Pomello con dispositivo di bloccaggio della regolazione.
- \* Utilizzabile nelle versioni per aria (con relieving e pomello rosso) e per acqua (senza relieving e pomello nero).
- \* Campi di pressione:  
0÷2 Bar, 0÷4 Bar, 0÷8 Bar (standard), 0÷12,5 Bar  
0÷0,2 MPa, 0÷0,4 MPa, 0÷0,8 MPa (standard), 0÷1,25 MPa
- \* Pressione massima d'ingresso: 16 Bar (1,60 MPa).
- \* Range di temperatura: 5÷50°C (41÷122°F).
- \* Coppia di serraggio max. inserti G1/8" IN-OUT: 20 N·m.
- \* Coppia di serraggio max. inserti G1/4" IN-OUT: 25 N·m.
- \* Portata di riferimento (P=6,3 Bar - Δp=1 Bar): 360 NI/min.
- \* Peso: 0,095 Kg.

## Microregulator

Suitable for many industrial uses.

- \* Diaphragm operation.
- \* Complete with ring nut for panel assembly.
- \* Can be wall mounted on a bracket.
- \* Lockable safety knob.
- \* Can be used in air (with relieving and red knob) and water (without relieving and with black knob).
- \* Pressure ranges:  
0÷2 Bar, 0÷4 Bar, 0÷8 Bar (standard), 0÷12,5 Bar  
0÷0,2 MPa, 0÷0,4 MPa, 0÷0,8 MPa (standard), 0÷1,25 MPa
- \* Maximum inlet pressure: 16 Bar (1,60 MPa).
- \* Temperature range: 5÷50°C (41÷122°F).
- \* Max. torque inserts G1/8" IN-OUT: 20 N·m.
- \* Max. torque inserts G1/4" IN-OUT: 25 N·m.
- \* Reference flow rate (P=6,3 Bar - Δp=1 Bar): 360 NI/min.
- \* Weight: 0,095 Kg.

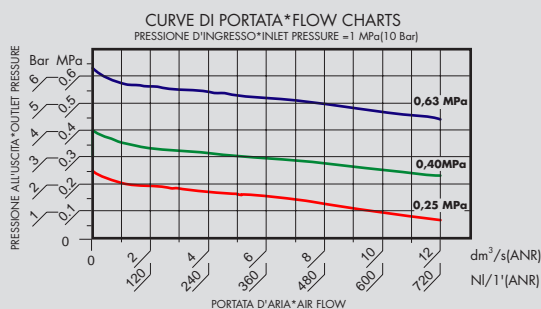
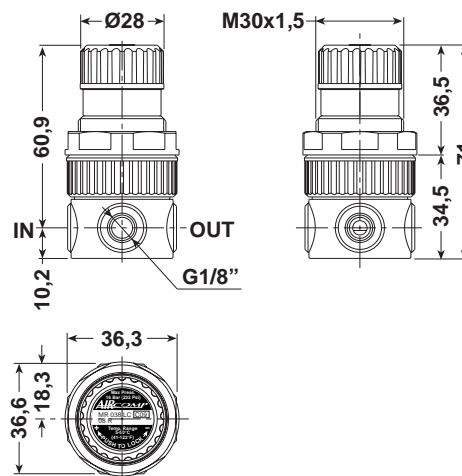
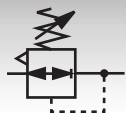

### Caratteristiche tecniche Technical Features

#### COMPONENTI

- 1- Perno membrana in "INOX"
- 2- Corpo valvola in "PUR"
- 3- Corpo regolatore in "POM"
- 4- Membrana in "EPDM"
- 5- Ugello in "POM"
- 6- Stelo valvola in "INOX"
- 7- Molla ritorno valvola in "INOX"

#### COMPONENTS

- 1- Diaphragm pin: INOX
- 2- Body valve: PUR
- 3- Regulator body: POM
- 4- Diaphragm: EPDM
- 5- Nozzle: POM
- 6- Valve rod: INOX
- 7- Spring return valve: INOX

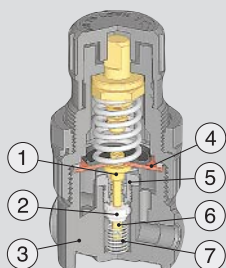

CORPO A 4 VIE  
(con 2 uscite manometro)

4 WAY BODY  
(With 2 gauge ports)

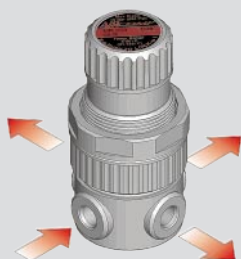

CORPO A 2 VIE  
(senza uscite manometro)

2 WAY BODY  
(Without gauge ports)

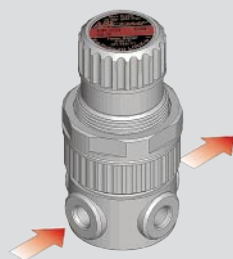

## Microregolatore LC

Modello speciale, particolarmente resistente alle aggressioni chimiche.

- \* Corpo interamente in "POM" a 2 o 4 vie da G1/8".
- \* Connessioni direttamente ricavate sul corpo (senza inserti).
- \* Componenti a contatto con il fluido: EPDM + INOX + PUR + POM.
- \* Montaggio e collaudo eseguiti in assenza di olii e grassi.
- \* Campi di pressione:  
0÷2 Bar, 0÷4 Bar, 0÷8 Bar (standard), 0÷12,5 Bar  
0÷0,2 MPa, 0÷0,4 MPa, 0÷0,8 MPa (standard), 0÷1,25 MPa
- \* Portata di riferimento (P=6,3 Bar - Δp=1 Bar): 360 NI/min.
- \* Peso: 0,078 Kg.

## Microregulator LC

Special type, particularly resistant to chemical agents.

- \* Body completely made in "POM" with 2 or 3 ways G1/8".
- \* Connections obtained directly on the body (without inserts).
- \* Components in touch with fluid made in: EPDM, INOX, PUR, POM.
- \* Assembly and test made without oil and grease.
- \* Pressure ranges:  
0÷2 Bar, 0÷4 Bar, 0÷8 Bar (standard), 0÷12,5 Bar  
0÷0,2 MPa, 0÷0,4 MPa, 0÷0,8 MPa (standard), 0÷1,25 MPa
- \* Reference flow rate (P=6,3 Bar - Δp=1 Bar): 360 NI/min.
- \* Weight: 0,078 Kg.

### Guida alle referenze Guide to references

MR 1/4" 038 08 R

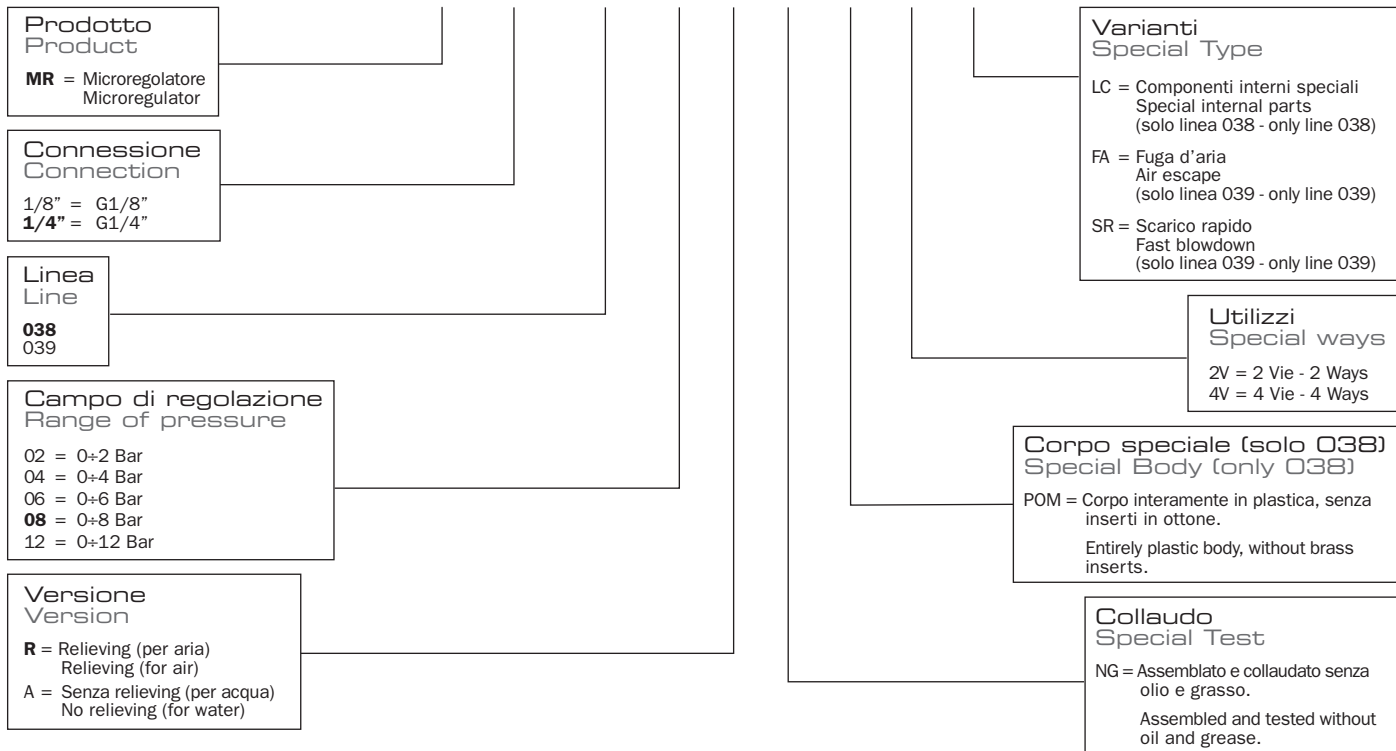

### Microregolatore "MR 038" Microregulator "MR 038"

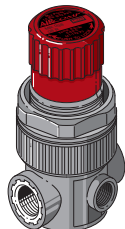

CODICE-CODE	REF.
038.00.00011	MR 1/8" 038 02 R
038.00.00009	MR 1/8" 038 04 R
038.00.00024	MR 1/8" 038 08 R
038.00.00021	MR 1/8" 038 12 R
038.00.00045	MR 1/8" 038 02 A
038.00.00043	MR 1/8" 038 04 A
038.00.00031	MR 1/8" 038 08 A
038.00.00044	MR 1/8" 038 12 A
038.00.00033	MR 1/4" 038 02 R
038.00.00041	MR 1/4" 038 04 R
038.00.00032	MR 1/4" 038 08 R
038.00.00034	MR 1/4" 038 12 R
038.00.00035	MR 1/4" 038 02 A
038.00.00025	MR 1/4" 038 04 A
038.00.00019	MR 1/4" 038 08 A
038.00.00023	MR 1/4" 038 12 A

### Microregolatore "MR 039" Microregulator "MR 039"

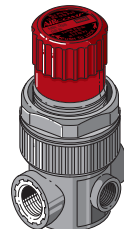

CODICE-CODE	REF.
039.00.00001	MR 1/8" 039 02 R
039.00.00002	MR 1/8" 039 04 R
039.00.00003	MR 1/8" 039 08 R
039.00.00004	MR 1/8" 039 12 R
039.00.00201	MR 1/8" 039 02 A
039.00.00202	MR 1/8" 039 04 A
039.00.00203	MR 1/8" 039 08 A
039.00.00204	MR 1/8" 039 12 A
039.00.00401	MR 1/4" 039 02 R
039.00.00402	MR 1/4" 039 04 R
039.00.00403	MR 1/4" 039 08 R
039.00.00404	MR 1/4" 039 12 R
039.00.00601	MR 1/4" 039 02 A
039.00.00602	MR 1/4" 039 04 A
039.00.00603	MR 1/4" 039 08 A
039.00.00604	MR 1/4" 039 12 A

### Microregolatore speciale "LC" Special Microregulator "LC"

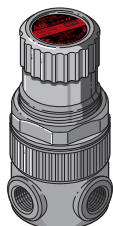

2 Vie 2 Ways	
CODICE-CODE	REF.
038.00.00129	MR 1/8" 038 NG 02 A 2V POM LC
038.00.00130	MR 1/8" 038 NG 04 A 2V POM LC
038.00.00092	MR 1/8" 038 NG 08 A 2V POM LC
038.00.00131	MR 1/8" 038 NG 12 A 2V POM LC
4 Vie 4 Ways	
CODICE-CODE	REF.
038.00.00126	MR 1/8" 038 NG 02 A 4V POM LC
038.00.00127	MR 1/8" 038 NG 04 A 4V POM LC
038.00.00120	MR 1/8" 038 NG 08 A 4V POM LC
038.00.00128	MR 1/8" 038 NG 12 A 4V POM LC

### Microregolatore "MR 039 FA" Microregulator "MR 039 FA"

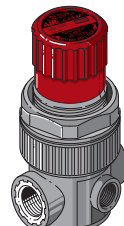

CODICE-CODE	REF.
039.00.00701	MR 1/8" 039 02 R FA
039.00.00702	MR 1/8" 039 04 R FA
039.00.00703	MR 1/8" 039 08 R FA
039.00.00704	MR 1/8" 039 12 R FA
039.00.00801	MR 1/4" 039 02 R FA
039.00.00802	MR 1/4" 039 04 R FA
039.00.00803	MR 1/4" 039 08 R FA
039.00.00804	MR 1/4" 039 12 R FA

→ = Standard version

### Microregolatore "non manomettabile" Microregulator "not adjustable"

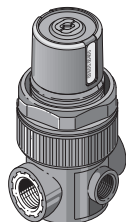

Microregolatore con pressione impostata a richiesta, con pomello bloccato antimanomissione.

Microregulators with pre-set pressure and fixed knob not adjustable.

### Microregolatore "MR 039 SR" Microregulator "MR 039 SR"

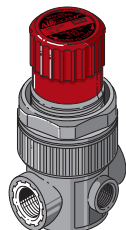

	CODICE-CODE	REF.
	039.00.00022	MR 1/8" 039 02 R SR
	039.00.00023	MR 1/8" 039 04 R SR
→	039.00.00024	MR 1/8" 039 08 R SR
	039.00.00025	MR 1/8" 039 12 R SR
	039.00.00441	MR 1/4" 039 02 R SR
	039.00.00442	MR 1/4" 039 04 R SR
→	039.00.00443	MR 1/4" 039 08 R SR
	039.00.00444	MR 1/4" 039 12 R SR

→ = Standard version

## Accessori e ricambi Spare parts

### Gruppo membrana completo Diaphragm complete

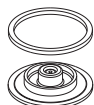

CODICE-CODE	LINE	VERSION
C38.00.00073	038	RELIEVING
C38.00.00074	038	NON RELIEVING
C38.00.00087	038 LC	NON RELIEVING
C39.00.00009	039	RELIEVING
C39.00.00010	039	NON RELIEVING

### Molla regolazione Regulation spring



CODICE-CODE	LINE	SET REGULATION
A38.00.00039	038-039	0±2 Bar
A38.00.00040	038-039	0±4 Bar
A38.00.00020	038-039	0±8 Bar
A38.00.00021	038-039	0±12 Bar

### Manometro Gauge



CODICE-CODE	Bar	Psi	A	B	CH.
A38.00.00026	0±12	0±175	40	G1/8"	14
A38.00.00055	0±6	0±85	40	G1/8"	12

### Staffa fissaggio a parete Bracket

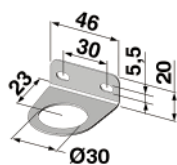

CODICE-CODE
C38.00.00069

### Grano G1/8" Plug G1/8"



CODICE-CODE	LINE
B38.00.00018	038 - 039