

SERIE

E

CILINDRO COMPATTO GUIDATO
GUIDED COMPACT CYLINDER

ARTEC[®]
PNEUMATIC COMPONENTS

CHIAVE DI CODIFICA

KEY CODE

E	D	M	0	5	0	.	0	3	0	.	G	S			
			ALESAGGIO - BORE (Ø)			CORSA - STROKE (mm)			OPZIONE - OPTION						
			016 - 020 - 025 - 032 040 - 050 - 063			vedere tabelle corse std see std stroke table			EX ATEX II 2GD c T4						
			VERSIONE - VERSION						OPZIONE - OPTION						
			con boccole in bronzo with bronze bushes						.S steli-viti-seeger inox SS rod screws-retaining ring						
			S con cuscinetti a ricircolo di sfere with recirculating ball bearings						OPZIONE - OPTION						
			VERSIONE - VERSION						senza ammortizzo pneumatico without pneumatic cushioning						
			M magnetico magnetic						.W con ammortizzo pneumatico with pneumatic cushioning						
			non magnetico non-magnetic												
			VERSIONE - VERSION						GUARNIZIONI - SEALS						
			D doppio effetto double acting						GS guarnizioni standard standard seals						
									VR guarnizione stelo per alte temperature high temperature rod seal						
									VA tutte le guarnizioni per alte temperature all seals for high temperature						
			SERIE - SERIES												
			E tubo profilato con cave per sensori profile tube with slots for sensors												

SERIE
E

ESECUZIONI A RICHIESTA - ON REQUEST

Doppia piastra - Double plate

Stelo prolungato (FB) - Extended rod (FB)

ATEX II 2GD c T4

FORZE TEORICHE DI TRAZIONE (P=6bar)

THEORETICAL FORCES OF TRACTION (P=6bar)

		Ø	016	020	025	032	040	050	063
EDM	SPINTA THRUST	[N]	121	188	295	483	754	1178	1870
	TRAZIONE TRACTION	[N]	90	141	247	415	686	1057	1750

ESEMPI DI FISSAGGIO

FIXING EXAMPLE

MONTAGGIO SUPERIORE
TOP MOUNTING

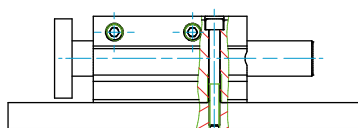

MONTAGGIO INFERIORE
BOTTOM MOUNTING

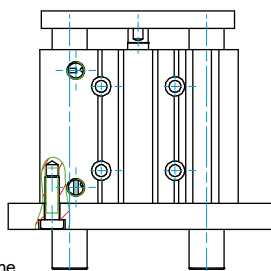

MONTAGGIO LATERALE
SIDE MOUNTING

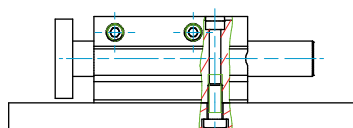

MONTAGGIO TRAMITE DADO NELLA CAVA A "T"
NUT INSIDE T-SLOT MOUNTING

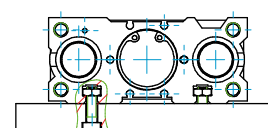

!!! Il fissaggio deve avvenire mediante viti amagnetiche
!!! The fixing must be with non-magnetic screws

DIAGRAMMA TEORICO CARICO AMMISSIBILE

THEORETICAL ALLOWABLE LOAD

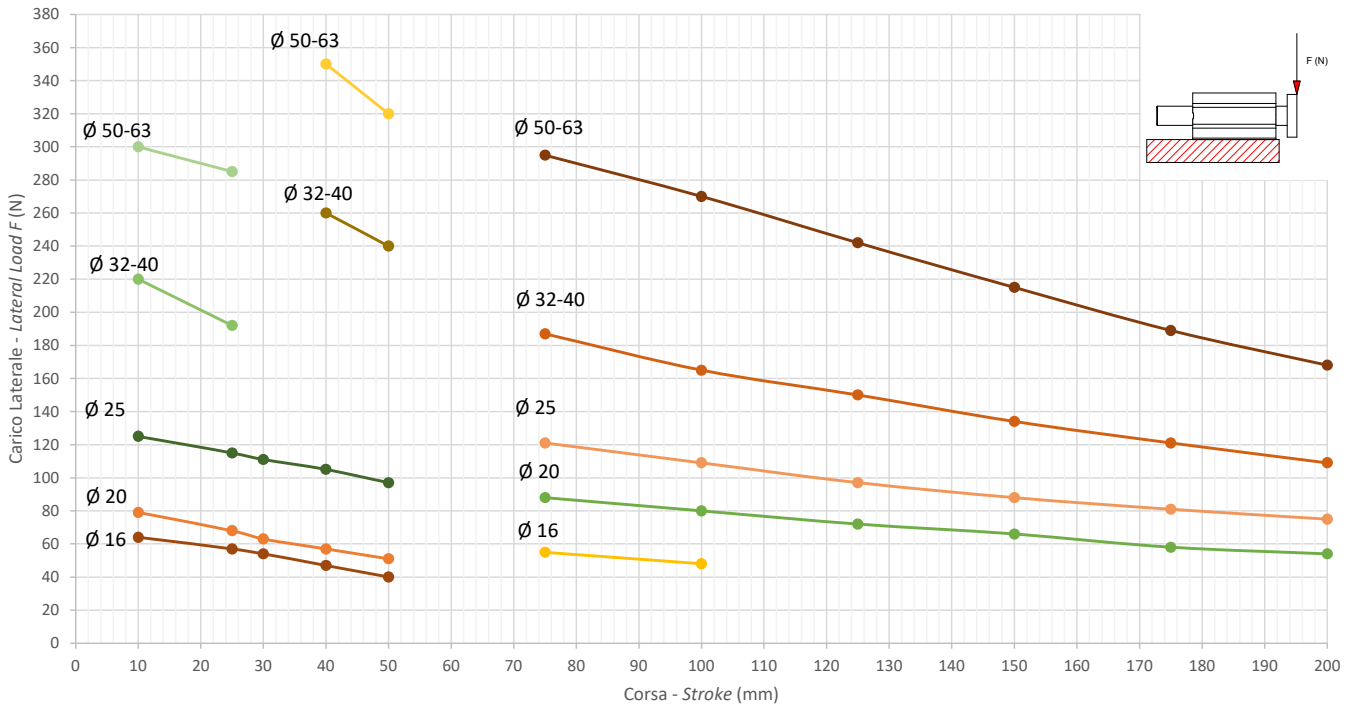

SERIE
E

DIAGRAMMA TEORICO CARICO AMMISSIBILE

THEORETICAL ALLOWABLE LOAD



DIAGRAMMA TEORICO CARICO AMMISSIBILE
THEORETICAL ALLOWABLE LOAD

**SERIE
E**
DIAGRAMMA TEORICO CARICO AMMISSIBILE
THEORETICAL ALLOWABLE LOAD

DIAGRAMMA TEORICO COPPIA AMMISSIBILE

THEORETICAL ALLOWABLE TORQUE

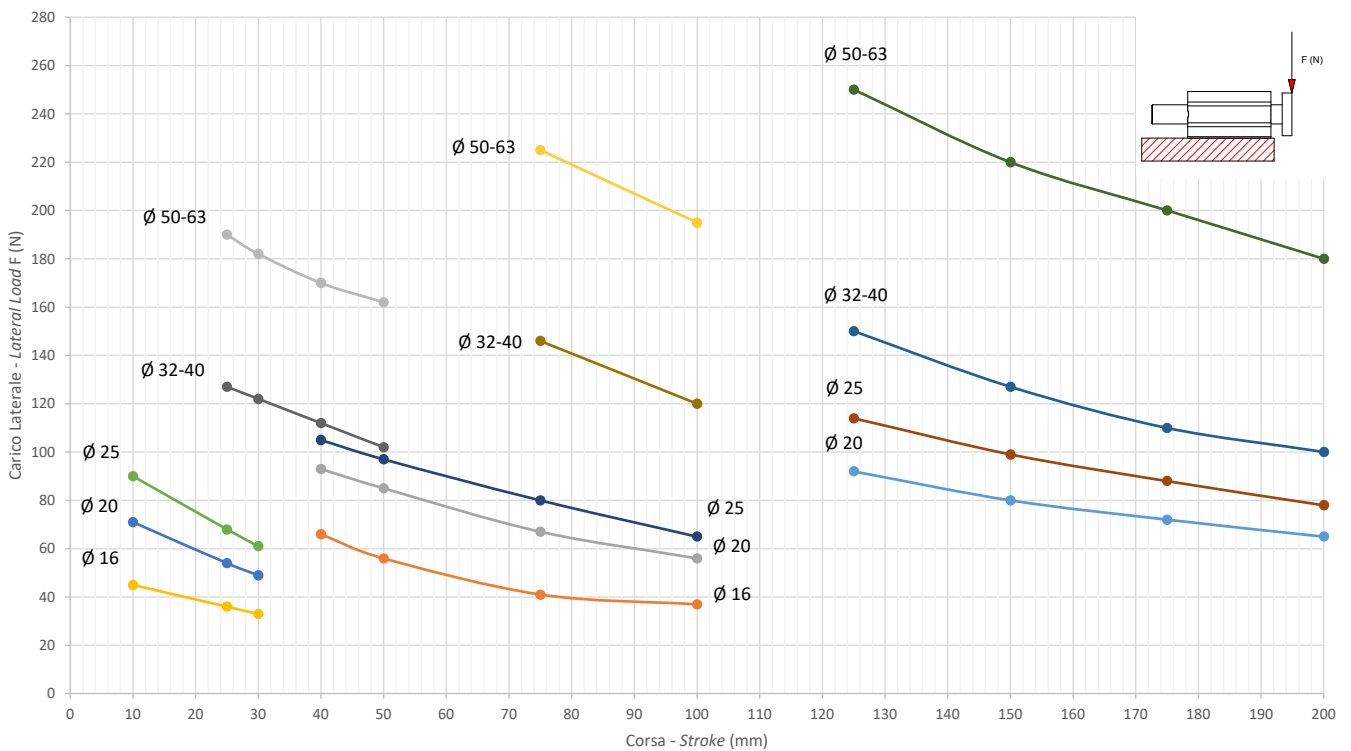

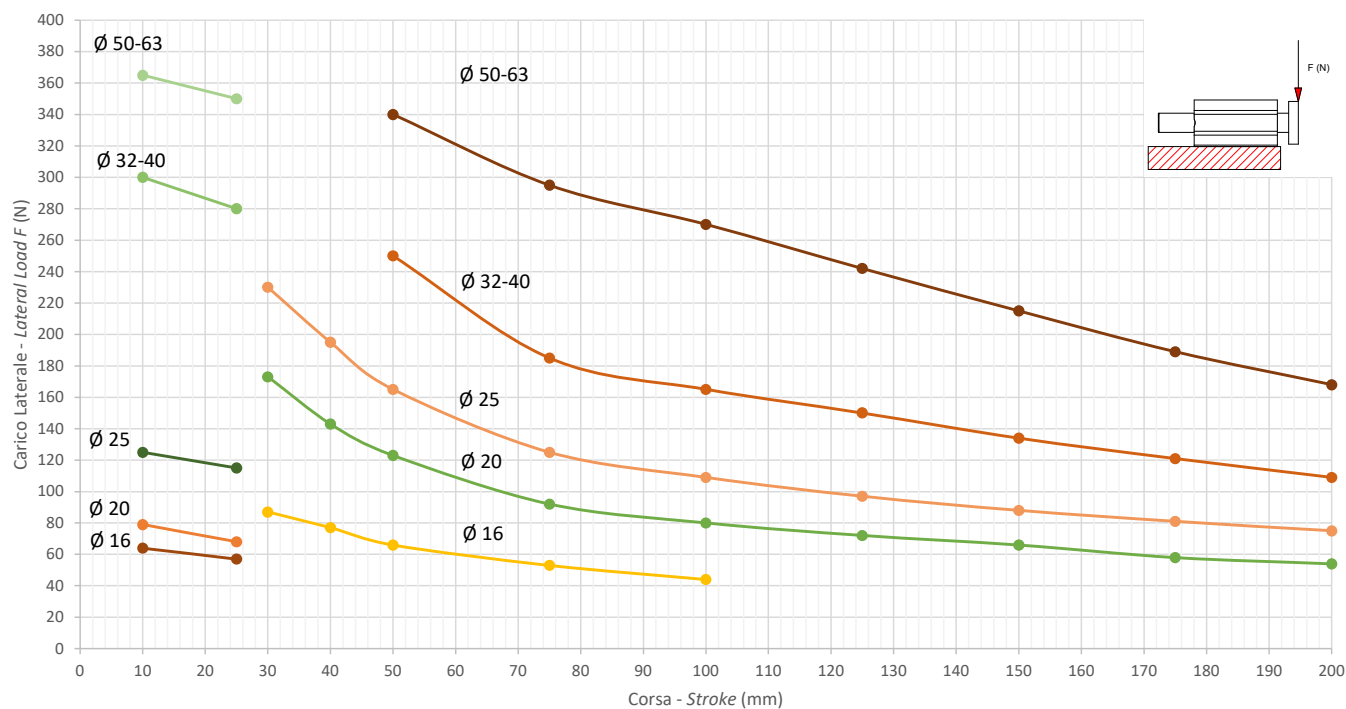
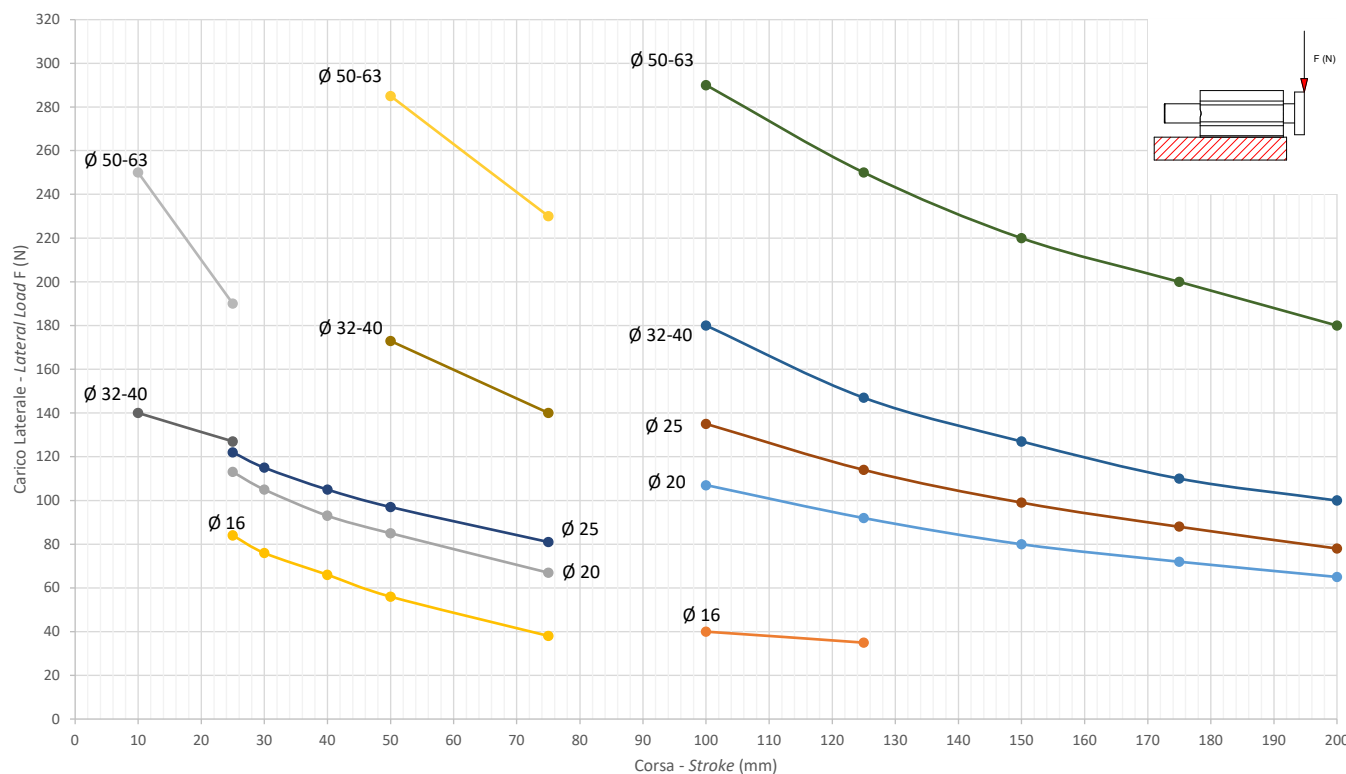
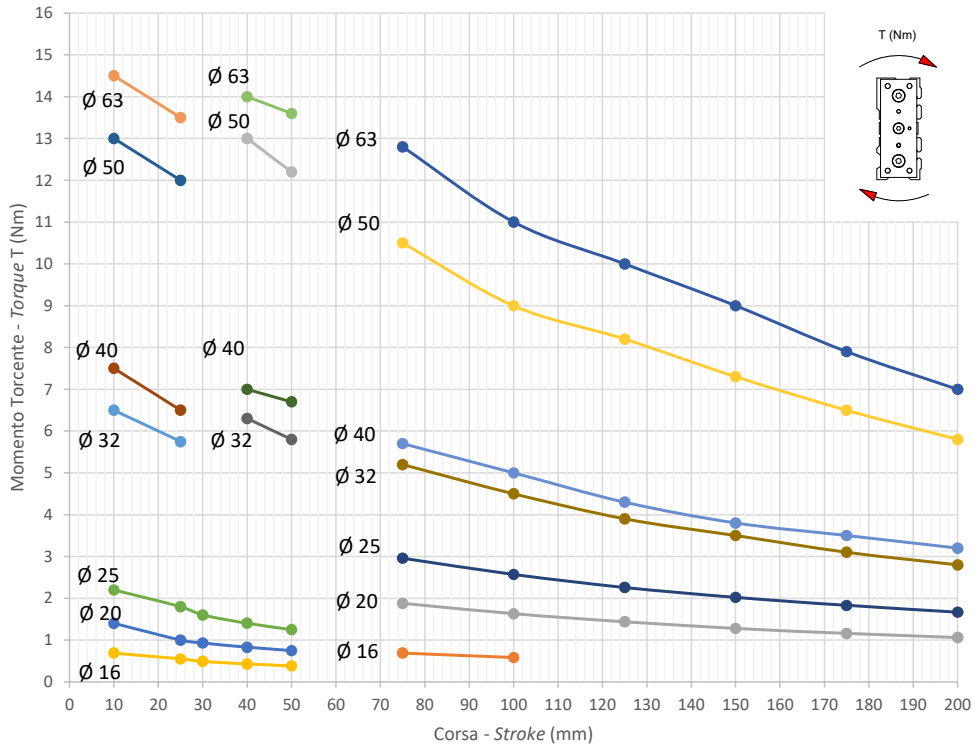
SERIE

E

DIAGRAMMA TEORICO COPPIA AMMISSIBILE

THEORETICAL ALLOWABLE TORQUE



DIAGRAMMA TEORICO COPPIA AMMISSIBILE
THEORETICAL ALLOWABLE TORQUE

**SERIE
E**
DIAGRAMMA TEORICO COPPIA AMMISSIBILE
THEORETICAL ALLOWABLE TORQUE

COMPATTO GUIDATO D.E.M.

D.A.M. GUIDED COMPACT

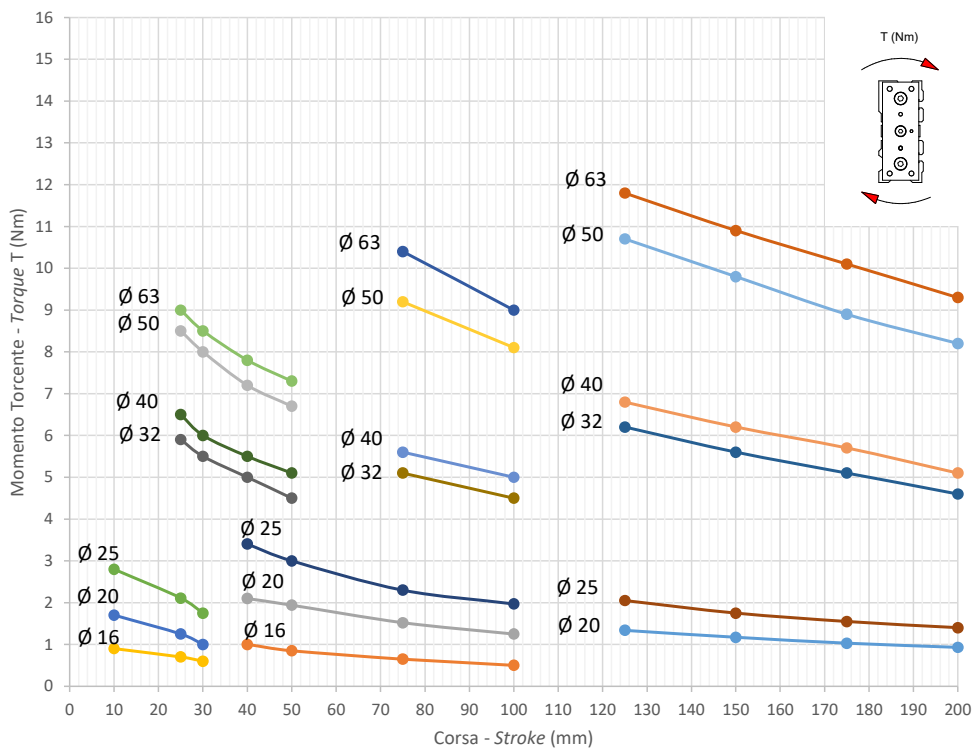
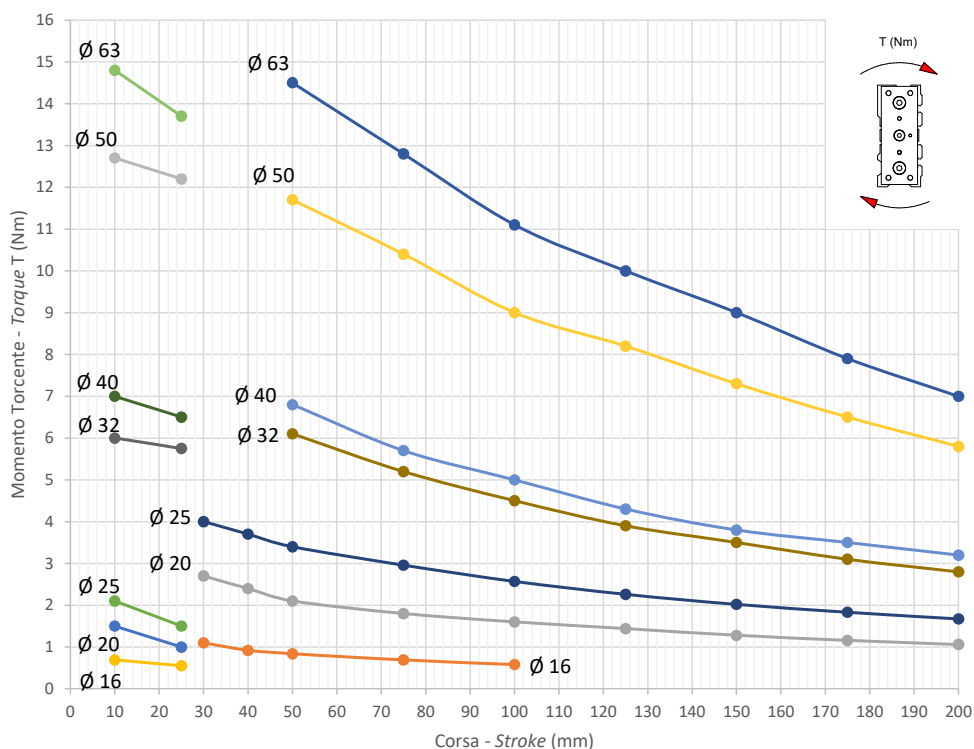
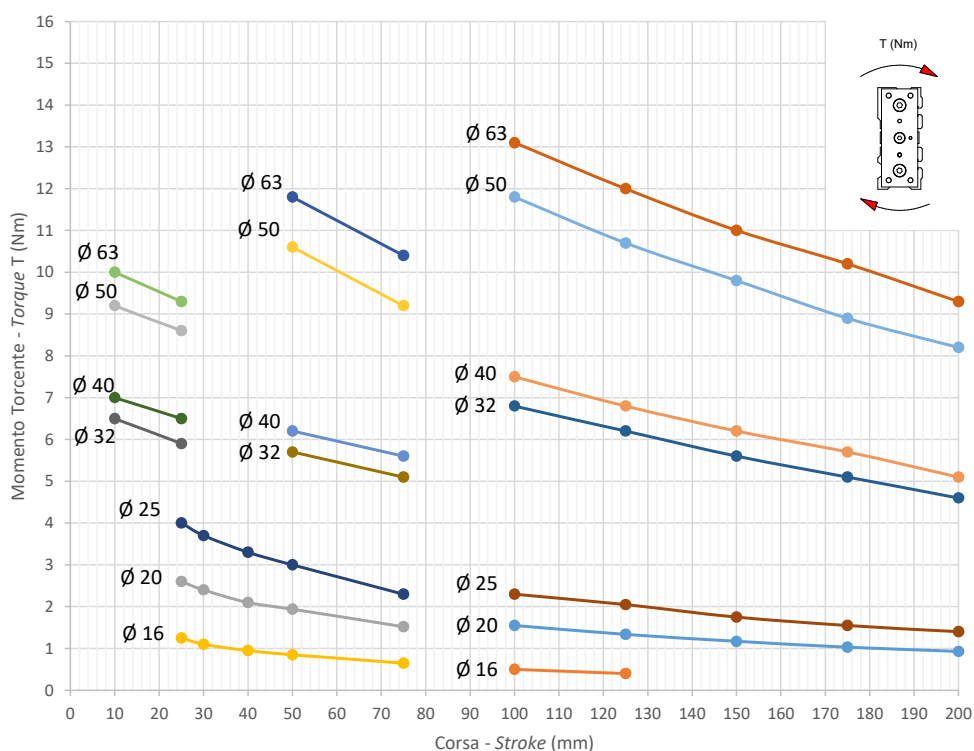
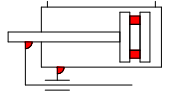

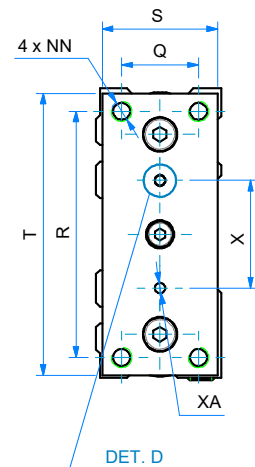
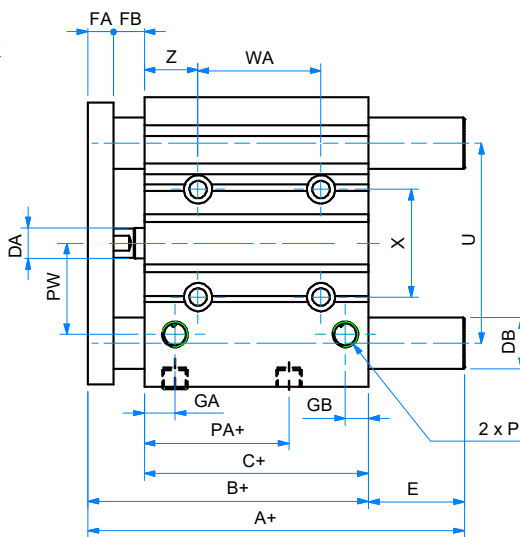
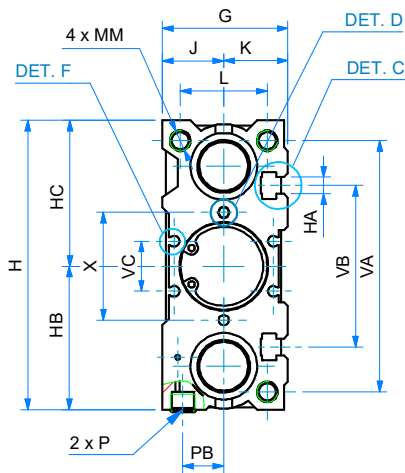
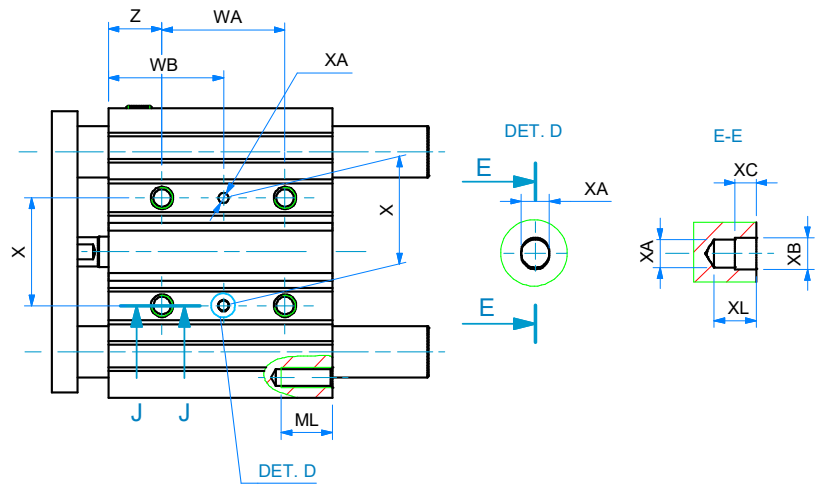
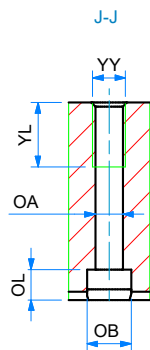
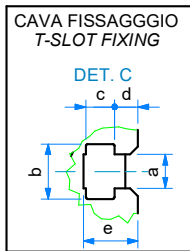
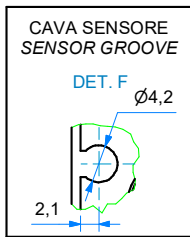
**CAVA SENSORE A C
C-SLOT FOR SENSOR**



θ	CORSE STANDARD - STANDARD STROKES
016	10 - 20 - 30 - 40 - 50 - 75 - 100 - 125 - 150 - 175 - 200 - 250
020	20 - 30 - 40 - 50 - 75 - 100 - 125 - 150 - 175 - 200 - 250 - 300 - 350 - 400
025	20 - 30 - 40 - 50 - 75 - 100 - 125 - 150 - 175 - 200 - 250 - 300 - 350 - 400
032	25 - 50 - 75 - 100 - 125 - 150 - 175 - 200 - 250 - 300 - 350 - 400
040	25 - 50 - 75 - 100 - 125 - 150 - 175 - 200 - 250 - 300 - 350 - 400
050	25 - 50 - 75 - 100 - 125 - 150 - 175 - 200 - 250 - 300 - 350 - 400
063	25 - 50 - 75 - 100 - 125 - 150 - 175 - 200 - 250 - 300 - 350 - 400

!!!: Le corse intermedie vengono realizzate con il corpo della corsa standard superiore e con distanziale interno per limitarne la corsa a quella richiesta.
Intermediate strokes are made with the profile of the standard superior stroke and with an internal spacer which limits the stroke to the required one.

DIMENSIONI - DIMENSIONS

ø	16	20	25	32	40	50	63
A+ (corsa-stroke 0÷50)	42	53	53,5	97	97	106,5	106,5
A+ (corsa-stroke 75÷200)	64,5	84,5	85	102	102	118	118
B+	46	53	53,5	59,5	66	72	77
C+	33	37	37,5	37,5	44	44	49
ø DA	8	10	10	12	12	16	16
ø DB	10	12	16	20	20	25	25
E (corsa-stroke 0÷50)	0	0	0	37,5	31	34,5	29,5
E (corsa-stroke 75÷200)	18,5	31,5	31,5	42,5	36	46	41
FA	8	10	10	10	10	15	15
FB	5	6	6	12	12	13	13
G	30,5	36,8	42,8	49	55	65	79
GA	11	11,5	11,5	12	15	15	15,5
GB	8	9	10	9	12	12	13,5
H	64	84	94	113	121	149	163
HA	M4	M5	M5	M6	M6	M8	M10
HB	32,5	41,5	46,5	56	60	74	81
HC	32	42,5	47,5	57	61	75	82
J	15	18	21	24	27	32	39
K	15,5	18,8	21,8	25	28	33	40
L	22	24	30	34	40	46	58
MM	M5	M5	M6	M8	M8	M10	M10
ML	12	13	15	16	16	20	22
NN	M5	M5	M6	M8	M8	M10	M10
OA	4,2	5,2	5,2	6,5	6,5	8,5	8,5
OB	8	9,5	9,5	11	11	14	14
OL	4,5	5,5	5,5	7,5	7,5	9	9
P	M5	G1/8	G1/8	G1/8	G1/8	G1/4	G1/4
PA+	15	13,5	12,5	6,5	13	9	13
PB	10	11	14	16	18	21,5	28
PW	19	25	30	35,5	39,5	47	58
Q	16	18	26	30	30	40	50
R	54	70	78	96	104	130	130
S	25	30	40	45	45	60	70
T	62	81	91	110	118	146	158
U	46	54	64	78	86	110	124
VA	56	72	82	98	106	130	142
VB	38	44	50	63	72	92	110
VC	10,5	12,5	15	19,5	25	33	34
WA (corsa-stroke 0÷30)	24	24	24	24	24	24	28
WA (corsa-stroke 40÷100)	44	44	44	48	48	48	52
WA (corsa-stroke 125÷200)	110	120	120	124	124	124	128
WB (corsa-stroke 0÷30)	17	29	29	33	34	36	38
WB (corsa-stroke 40÷100)	27	39	39	45	46	48	50
WB (corsa-stroke 125÷200)	60	77	77	83	84	86	88
X ± 0,02	24	28	34	42	50	66	80
ø XA H9	3	3	4	4	4	5	5
XB	3,5	3,5	4,5	4,5	4,5	6	6
XC	3	3	3	3	3	4	4
XL	6	6	6	6	6	8	8
YY	M5	M6	M6	M8	M8	M10	M10
YL	10	12	12	16	16	20	22
Z	5	17	17	21	22	24	24
a	4,4	5,4	5,4	6,5	6,5	8,5	11
b	7,4	8,4	8,4	10,5	10,5	13,5	17,8
c	3,7	4,5	4,5	5,5	5,5	7,5	10
d	3,5	3,6	3,8	4,5	5	5,5	8
e	6,7	8,6	9	10,5	10,5	14,5	19,5

COMPATTO GUIDATO D.E.M. CON CUSCINETTI A RICIRCOLO DI SFERE

D.A.M. GUIDED COMPACT WITH RECIRCULATING BALL BEARINGS

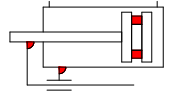

CAVA SENSORE A C
C-SLOT FOR SENSOR

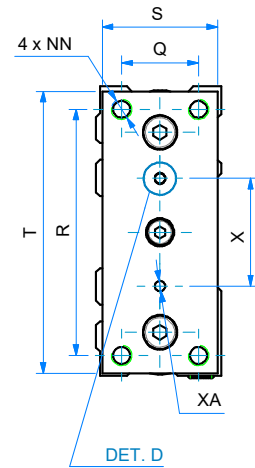
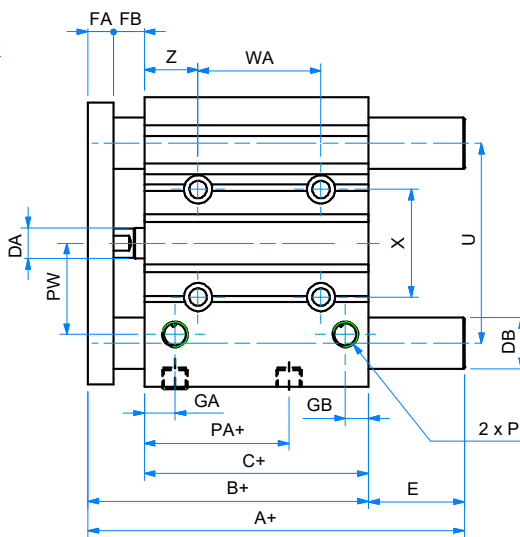
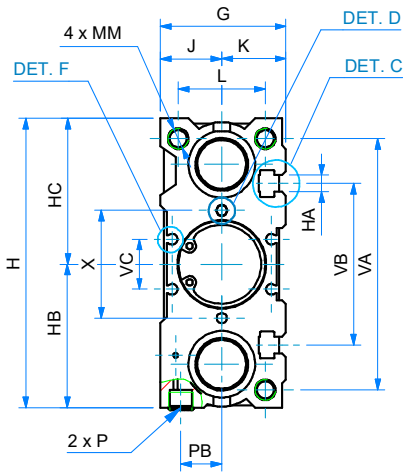
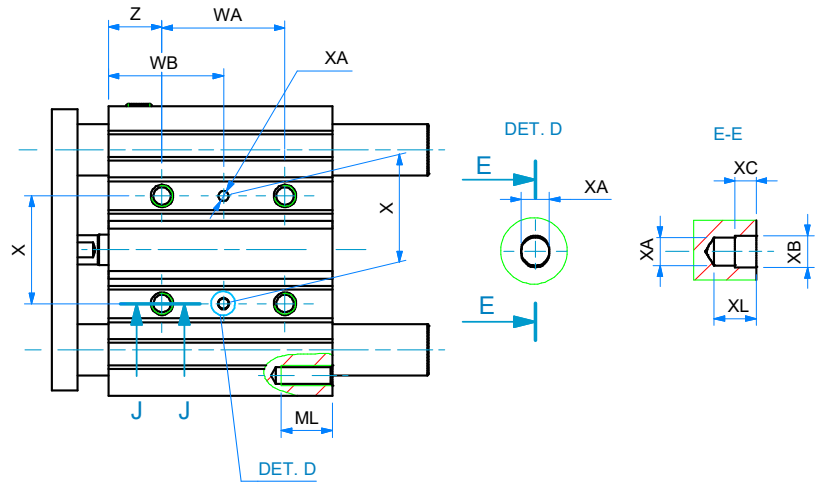
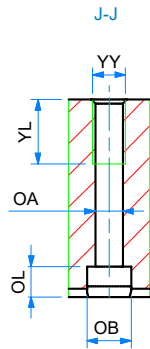
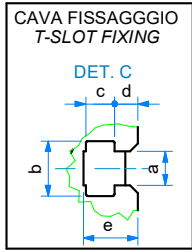
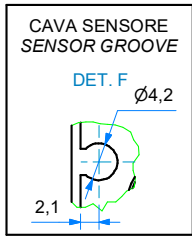

Ø	CORSE STANDARD - STANDARD STROKES
016	10 - 20 - 30 - 40 - 50 - 75 - 100 - 125 - 150 - 175 - 200 - 250
020	20 - 30 - 40 - 50 - 75 - 100 - 125 - 150 - 175 - 200 - 250 - 300 - 350 - 400
025	20 - 30 - 40 - 50 - 75 - 100 - 125 - 150 - 175 - 200 - 250 - 300 - 350 - 400
032	25 - 50 - 75 - 100 - 125 - 150 - 175 - 200 - 250 - 300 - 350 - 400
040	25 - 50 - 75 - 100 - 125 - 150 - 175 - 200 - 250 - 300 - 350 - 400
050	25 - 50 - 75 - 100 - 125 - 150 - 175 - 200 - 250 - 300 - 350 - 400
063	25 - 50 - 75 - 100 - 125 - 150 - 175 - 200 - 250 - 300 - 350 - 400

!!!: Le corse intermedie vengono realizzate con il corpo della corsa standard superiore e con distanziale interno per limitarne la corsa a quella richiesta.
Intermediate strokes are made with the profile of the standard superior stroke and with an internal spacer which limits the stroke to the required one.

DIMENSIONI - DIMENSIONS

CON CUSCINETTI A RICIRCOLO DI SFERE - WITH RECIRCULATING BALL BEARINGS

ø	16	20	25	32	40	50	63
A+ (corsa-stroke 0÷30)	49	63	69,5	-	-	-	-
A+ (corsa-stroke 40÷100)	65	80	86	-	-	-	-
A+ (corsa-stroke 125÷200)	-	104	104,5	-	-	-	-
A+ (corsa-stroke 0÷50)	-	-	-	81	81	93	93
A+ (corsa-stroke 75÷100)	-	-	-	98	98	114	114
A+ (corsa-stroke 125÷200)	-	-	-	118	118	134	134
B+	46	53	53,5	59,5	66	72	77
C+	33	37	37,5	37,5	44	44	49
ø DA	8	10	10	12	12	16	16
ø DB	8	12	14	20	20	25	25
E (corsa-stroke 0÷30)	3	10	16	-	-	-	-
E (corsa-stroke 40÷100)	19	27	32,5	-	-	-	-
E (corsa-stroke 125÷200)	-	51	51	-	-	-	-
E (corsa-stroke 0÷50)	-	-	-	21,5	15	21	16
E (corsa-stroke 75÷100)	-	-	-	38,5	32	42	37
E (corsa-stroke 125÷200)	-	-	-	58,5	52	62	57
FA	8	10	10	10	10	15	15
FB	5	6	6	12	12	13	13
G	30,5	36,8	42,8	49	55	65	79
GA	11	11,5	11,5	12	15	15	15,5
GB	8	9	10	9	12	12	13,5
H	64	84	94	113	121	149	163
HA	M4	M5	M5	M6	M6	M8	M10
HB	32,5	41,5	46,5	56	60	74	81
HC	32	42,5	47,5	57	61	75	82
J	15	18	21	24	27	32	39
K	15,5	18,8	21,8	25	28	33	40
L	22	24	30	34	40	46	58
MM	M5	M5	M6	M8	M8	M10	M10
ML	12	13	15	16	16	20	22
NN	M5	M5	M6	M8	M8	M10	M10
OA	4,2	5,2	5,2	6,5	6,5	8,5	8,5
OB	8	9,5	9,5	11	11	14	14
OL	4,5	5,5	5,5	7,5	7,5	9	9
P	M5	G1/8	G1/8	G1/8	G1/8	G1/4	G1/4
PA+	15	13,5	12,5	6,5	13	9	13
PB	10	11	14	16	18	21,5	28
PW	19	25	30	35,5	39,5	47	58
Q	16	18	26	30	30	40	50
R	54	70	78	96	104	130	130
S	25	30	40	45	45	60	70
T	62	81	91	110	118	146	158
U	46	54	64	78	86	110	124
VA	56	72	82	98	106	130	142
VB	38	44	50	63	72	92	110
VC	10,5	12,5	15	19,5	25	33	34
WA (corsa-stroke 0÷30)	24	24	24	24	24	24	28
WA (corsa-stroke 40÷100)	44	44	44	48	48	48	52
WA (corsa-stroke 125÷200)	110	120	120	124	124	124	128
WB (corsa-stroke 0÷30)	17	29	29	33	34	36	38
WB (corsa-stroke 40÷100)	27	39	39	45	46	48	50
WB (corsa-stroke 125÷200)	60	77	77	83	84	86	88
X ± 0,02	24	28	34	42	50	66	80
ø XA H9	3	3	4	4	4	5	5
XB	3,5	3,5	4,5	4,5	4,5	6	6
XC	3	3	3	3	3	4	4
XL	6	6	6	6	6	8	8
YY	M5	M6	M6	M8	M8	M10	M10
YL	10	12	12	16	16	20	22
Z	5	17	17	21	22	24	24
a	4,4	5,4	5,4	6,5	6,5	8,5	11
b	7,4	8,4	8,4	10,5	10,5	13,5	17,8
c	3,7	4,5	4,5	5,5	5,5	7,5	10
d	3,5	3,6	3,8	4,5	5	5,5	8
e	6,7	8,6	9	10,5	10,5	14,5	19,5

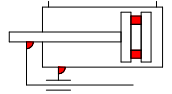

**CAVA SENSORE A T
T-SLOT FOR SENSOR**

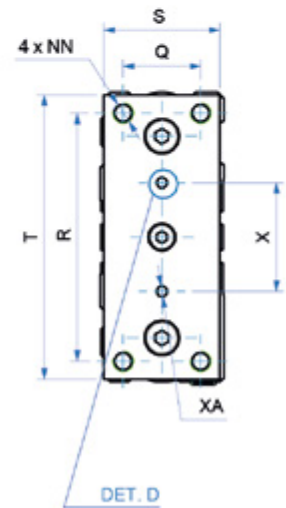
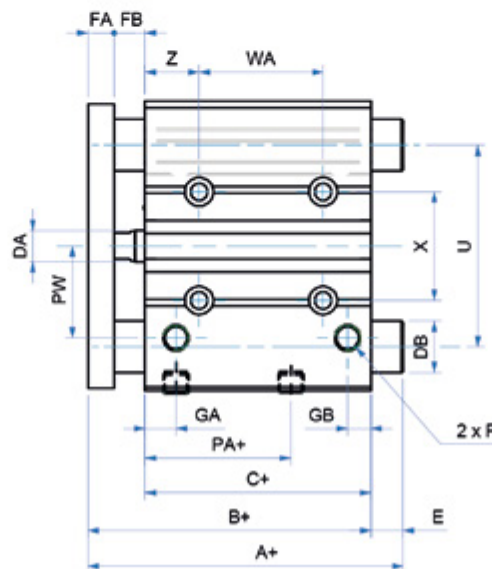
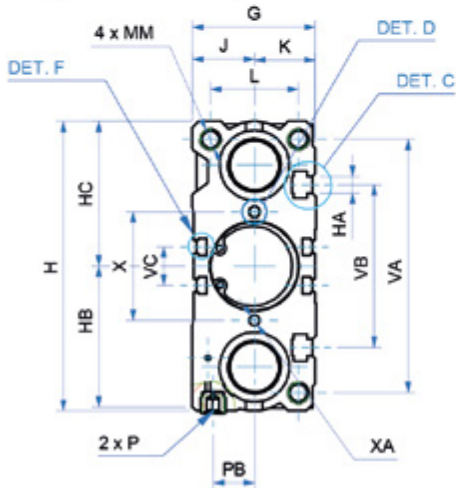
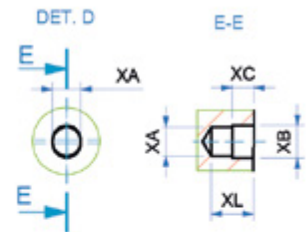
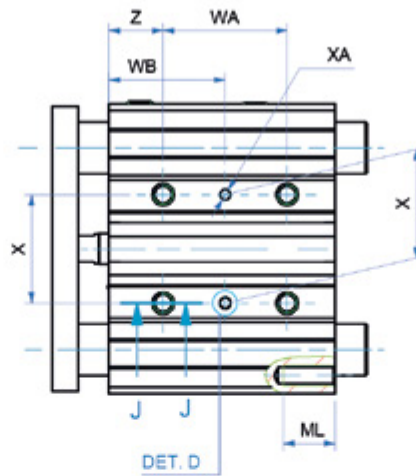
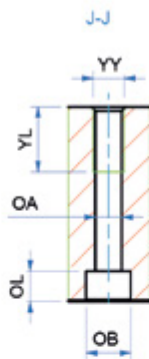
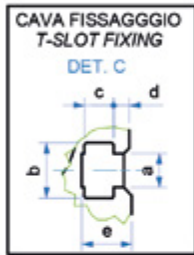

0	CORSE STANDARD - STANDARD STROKES
016	10 - 20 - 30 - 40 - 50 - 75 - 100 - 125 - 150 - 175 - 200 - 250
020	20 - 30 - 40 - 50 - 75 - 100 - 125 - 150 - 175 - 200 - 250 - 300 - 350 - 400
025	20 - 30 - 40 - 50 - 75 - 100 - 125 - 150 - 175 - 200 - 250 - 300 - 350 - 400
032	25 - 50 - 75 - 100 - 125 - 150 - 175 - 200 - 250 - 300 - 350 - 400
040	25 - 50 - 75 - 100 - 125 - 150 - 175 - 200 - 250 - 300 - 350 - 400
050	25 - 50 - 75 - 100 - 125 - 150 - 175 - 200 - 250 - 300 - 350 - 400
063	25 - 50 - 75 - 100 - 125 - 150 - 175 - 200 - 250 - 300 - 350 - 400

!!!: Le corse intermedie vengono realizzate con il corpo della corsa standard superiore e con distanziale interno per limitarne la corsa a quella richiesta.

Intermediate strokes are made with the profile of the standard superior stroke and with an internal spacer which limits the stroke to the required one.

E1DM

DIMENSIONI - DIMENSIONS

CON BOCCOLE IN BRONZO - WITH BRONZE BUSH

Ø	16	20	25	32	40	50	63
A+ (corsa-stroke 0÷50)	42	53	53,5	97	97	106,5	106,5
A+ (corsa-stroke 75÷200)	64,5	84,5	85	102	102	118	118
A+ (corsa-stroke 250÷400)							
B+	46	53	53,5	59,5	66	72	77
C+	33	37	37,5	37,5	44	44	49
Ø DA	8	10	10	12	12	16	16
Ø DB	10	12	16	20	20	25	25
E (corsa-stroke 0÷50)	0	0	0	37,5	31	34,5	29,5
E (corsa-stroke 75÷200)	18,5	31,5	31,5	42,5	36	46	41
E (corsa-stroke 250÷400)							
FA	8	10	10	10	10	15	15
FB	5	6	6	12	12	13	13
G	30	36	42	48	54	64	78
GA	11	11,5	11,5	12	15	15	15,5
GB	8	9	10	9	12	12	13,5
H	64	84	94	113	121	149	163
HA	M4	M5	M5	M6	M6	M8	M10
HB	32,5	41,5	46,5	56	60	74	81
HC	32	42,5	47,5	57	61	75	82
J	15	18	21	24	27	32	39
K	15	18	21	24	27	32	39
L	22	24	30	34	40	46	58
MM	M5	M5	M6	M8	M8	M10	M10
ML	12	13	15	16	16	20	22
NN	M5	M5	M6	M8	M8	M10	M10
OA	4,2	5,2	5,2	6,5	6,5	8,5	8,5
OB	8	9,5	9,5	11	11	14	14
OL	4,5	5,5	5,5	7,5	7,5	9	9
P	M5	G1/8	G1/8	G1/8	G1/8	G1/4	G1/4
PA+	15	13,5	12,5	6,5	13	9	13
PB	10	11	14	16	18	21,5	28
PW	19	25	30	35,5	39,5	47	58
Q	16	18	26	30	30	40	50
R	54	70	78	96	104	130	130
S	25	30	40	45	45	60	70
T	62	81	91	110	118	146	158
U	46	54	64	78	86	110	124
VA	56	72	82	98	106	130	142
VB	38	44	50	63	72	92	110
VC	10,5	12,5	15	19,5	25	33	34
WA (corsa-stroke 0÷30)	24	24	24	24	24	24	28
WA (corsa-stroke 40÷100)	44	44	44	48	48	48	52
WA (corsa-stroke 125÷200)	110	120	120	124	124	124	128
WB (corsa-stroke 0÷30)	17	29	29	33	34	36	38
WB (corsa-stroke 40÷100)	27	39	39	45	46	48	50
WB (corsa-stroke 125÷200)	60	77	77	83	84	86	88
X ± 0,02	24	28	34	42	50	66	80
Ø XA H9	3	3	4	4	4	5	5
XB	3,5	3,5	4,5	4,5	4,5	6	6
XC	3	3	3	3	3	4	4
XL	6	6	6	6	6	8	8
YY	M5	M6	M6	M8	M8	M10	M10
YL	10	12	12	16	16	20	22
Z	5	17	17	21	22	24	24
a	4,4	5,4	5,4	6,5	6,5	8,5	11
b	7,4	8,4	8,4	10,5	10,5	13,5	17,8
c	3,7	4,5	4,5	5,5	5,5	7,5	10
d	3,5	3,6	3,8	4,5	5	5,5	8
e	6,7	8,6	9	10,5	10,5	14,5	19,5

SERIE

E

COMPATTO GUIDATO D.E.M. CON CUSCINETTI A RICIRCOLO DI SFERE

D.A.M. GUIDED COMPACT WITH RECIRCULATING BALL BEARINGS

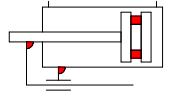

CAVA SENSORE A T
T-SLOT FOR SENSOR

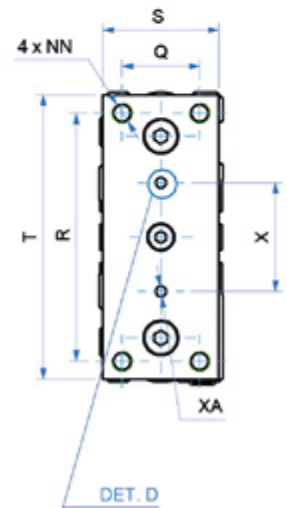
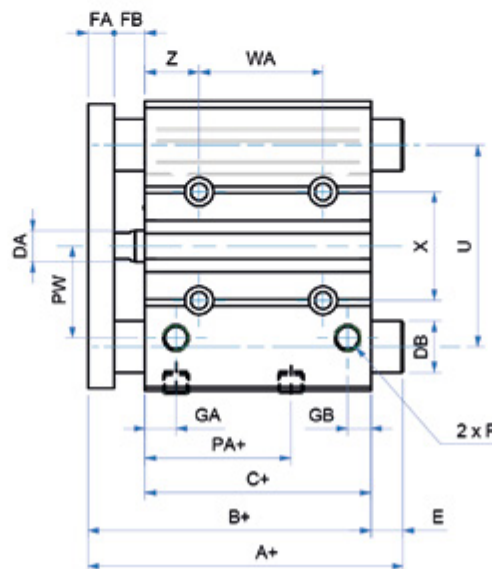
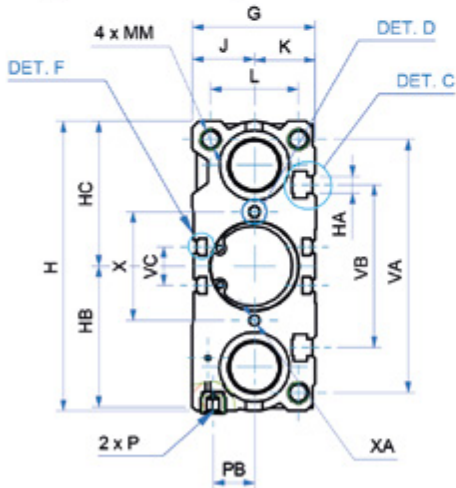
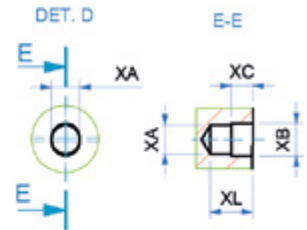
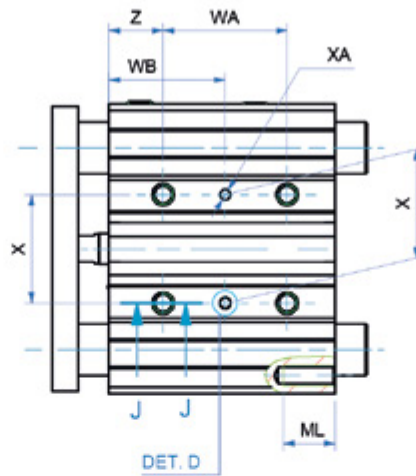
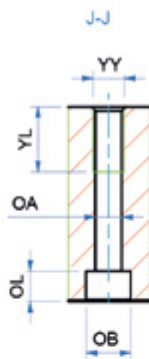
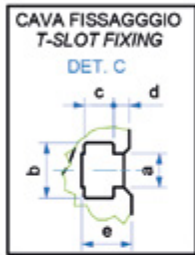

0 CORSE STANDARD - STANDARD STROKES

016	10 - 20 - 30 - 40 - 50 - 75 - 100 - 125 - 150 - 175 - 200 - 250
020	20 - 30 - 40 - 50 - 75 - 100 - 125 - 150 - 175 - 200 - 250 - 300 - 350 - 400
025	20 - 30 - 40 - 50 - 75 - 100 - 125 - 150 - 175 - 200 - 250 - 300 - 350 - 400
032	25 - 50 - 75 - 100 - 125 - 150 - 175 - 200 - 250 - 300 - 350 - 400
040	25 - 50 - 75 - 100 - 125 - 150 - 175 - 200 - 250 - 300 - 350 - 400
050	25 - 50 - 75 - 100 - 125 - 150 - 175 - 200 - 250 - 300 - 350 - 400
063	25 - 50 - 75 - 100 - 125 - 150 - 175 - 200 - 250 - 300 - 350 - 400

!!!: Le corse intermedie vengono realizzate con il corpo della corsa standard superiore e con distanziale interno per limitarne la corsa a quella richiesta.

Intermediate strokes are made with the profile of the standard superior stroke and with an internal spacer which limits the stroke to the required one.

DIMENSIONI - DIMENSIONS

CON CUSCINETTI A RICIRCOLO DI SFERE - WITH RECIRCULATING BALL BEARINGS

	16	20	25	32	40	50	63
A+ (corsa-stroke 0÷30)	49	63	69,5	-	-	-	-
A+ (corsa-stroke 40÷100)	65	80	86	-	-	-	-
A+ (corsa-stroke 125÷200)	-	104	104,5	-	-	-	-
A+ (corsa-stroke 0÷50)	-	-	-	81	81	93	93
A+ (corsa-stroke 75÷100)	-	-	-	98	98	114	114
A+ (corsa-stroke 125÷200)	-	-	-	118	118	134	134
A+ (corsa-stroke 250÷400)	-	-	-	-	-	-	-
B+	46	53	53,5	59,5	66	72	77
C+	33	37	37,5	37,5	44	44	49
ø DA	8	10	10	12	12	16	16
ø DB	8	12	14	20	20	25	25
E (corsa-stroke 0÷30)	3	10	16	-	-	-	-
E (corsa-stroke 40÷100)	19	27	32,5	-	-	-	-
E (corsa-stroke 125÷200)	-	51	51	-	-	-	-
E (corsa-stroke 0÷50)	-	-	-	21,5	15	21	16
E (corsa-stroke 75÷100)	-	-	-	38,5	32	42	37
E (corsa-stroke 125÷200)	-	-	-	58,5	52	62	57
E (corsa-stroke 250÷400)	-	-	-	-	-	-	-
FA	8	10	10	10	10	15	15
FB	5	6	6	12	12	13	13
G	30	36	42	48	54	64	78
GA	11	11,5	11,5	12	15	15	15,5
GB	8	9	10	9	12	12	13,5
H	64	84	94	113	121	149	163
HA	M4	M5	M5	M6	M6	M8	M10
HB	32,5	41,5	46,5	56	60	74	81
HC	32	42,5	47,5	57	61	75	82
J	15	18	21	24	27	32	39
K	15	18	21	24	27	32	39
L	22	24	30	34	40	46	58
MM	M5	M5	M6	M8	M8	M10	M10
ML	12	13	15	16	16	20	22
NN	M5	M5	M6	M8	M8	M10	M10
OA	4,2	5,2	5,2	6,5	6,5	8,5	8,5
OB	8	9,5	9,5	11	11	14	14
OL	4,5	5,5	5,5	7,5	7,5	9	9
P	M5	G1/8	G1/8	G1/8	G1/8	G1/4	G1/4
PA+	15	13,5	12,5	6,5	13	9	13
PB	10	11	14	16	18	21,5	28
PW	19	25	30	35,5	39,5	47	58
Q	16	18	26	30	30	40	50
R	54	70	78	96	104	130	130
S	25	30	40	45	45	60	70
T	62	81	91	110	118	146	158
U	46	54	64	78	86	110	124
VA	56	72	82	98	106	130	142
VB	38	44	50	63	72	92	110
VC	10,5	12,5	15	19,5	25	33	34
WA (corsa-stroke 0÷30)	24	24	24	24	24	24	28
WA (corsa-stroke 40÷100)	44	44	44	48	48	48	52
WA (corsa-stroke 125÷200)	110	120	120	124	124	124	128
WA (corsa-stroke 250÷400)	-	-	-	-	-	-	-
WB (corsa-stroke 0÷30)	17	29	29	33	34	36	38
WB (corsa-stroke 40÷100)	27	39	39	45	46	48	50
WB (corsa-stroke 125÷200)	60	77	77	83	84	86	88
WB (corsa-stroke 250÷400)	-	-	-	-	-	-	-
X ± 0,02	24	28	34	42	50	66	80
ø XA H9	3	3	4	4	4	5	5
XB	3,5	3,5	4,5	4,5	4,5	6	6
XC	3	3	3	3	3	4	4
XL	6	6	6	6	6	8	8
YY	M5	M6	M6	M8	M8	M10	M10
YL	10	12	12	16	16	20	22
Z	5	17	17	21	22	24	24
a	4,4	5,4	5,4	6,5	6,5	8,5	11
b	7,4	8,4	8,4	10,5	10,5	13,5	17,8
c	3,7	4,5	4,5	5,5	5,5	7,5	10
d	3,5	3,6	3,8	4,5	5	5,5	8
e	6,7	8,6	9	10,5	10,5	14,5	19,5

COMPATTO GUIDATO D.E.M. CON BOCCOLE IN BRONZO AMMORTIZZATO

D.A.M. GUIDED COMPACT WITH BRONZE BUSHES CUSHIONED

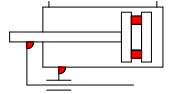

**CAVA SENSORE A T
T-SLOT FOR SENSOR**

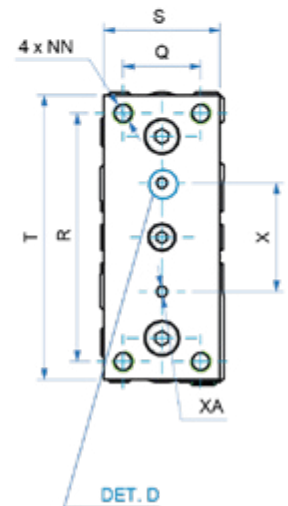
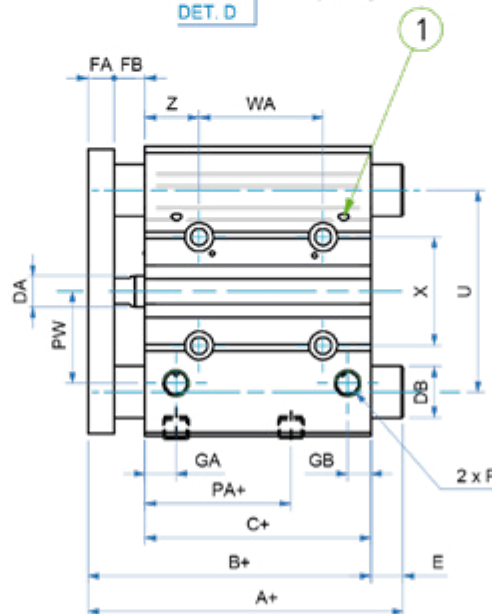
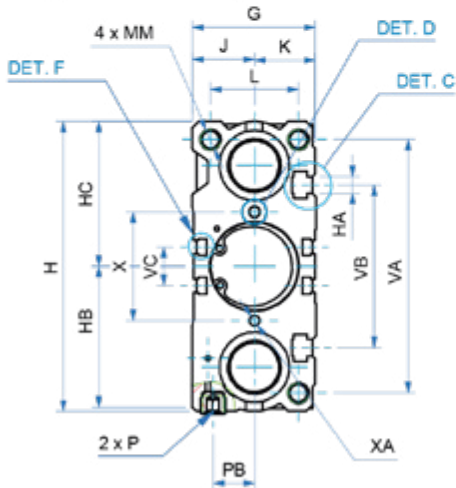
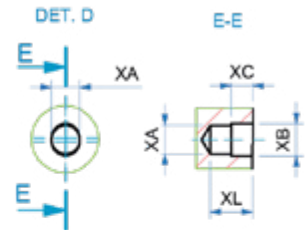
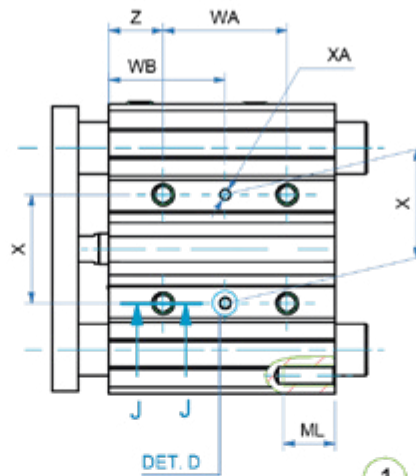
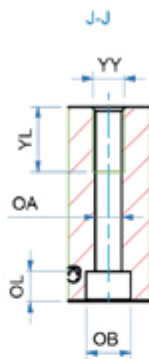
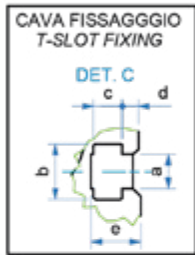
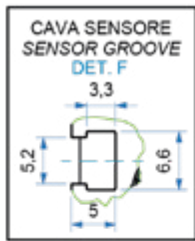

① Vite regolazione ammortizzo - Cushioning adjustment screw

9 CORSE STANDARD - STANDARD STROKES

016	25 - 50 - 75 - 100
020	25 - 50 - 75 - 100 - 125 - 150 - 175 - 200 - 250
025	25 - 50 - 75 - 100 - 125 - 150 - 175 - 200 - 250
032	25 - 50 - 75 - 100 - 125 - 150 - 175 - 200 - 250
040	25 - 50 - 75 - 100 - 125 - 150 - 175 - 200 - 250
050	25 - 50 - 75 - 100 - 125 - 150 - 175 - 200 - 250
063	25 - 50 - 75 - 100 - 125 - 150 - 175 - 200 - 250

!!!: Le corse intermedie della versione ammortizzata non sono realizzabili (per ulteriori informazioni contattare l'ufficio commerciale)

Intermediate strokes of versions with cushioning are not possible (for further information, please contact our sales department)

E1DM-W

DIMENSIONI - DIMENSIONS

CON BOCCOLE IN BRONZO - WITH BRONZE BUSH

	16	20	25	32	40	50	63
A+ (corsa-stroke 0÷25)	71	78	78,5	97	97	106,5	106,5
A+ (corsa-stroke >25÷50)	71	86,5	87	127	127	131,5	131,5
A+ (corsa-stroke 75÷200)	71	84,5	85	102	102	118	118
A+ (corsa-stroke 250)	-						
B+	71	78	78,5	84,5	91	97	102
C+	58	62	62,5	62,5	69	69	74
oDA	8	10	10	12	12	16	16
oDB	10	12	16	20	20	25	25
E (corsa-stroke 0÷25)	0	0	0	12,5	6	9,5	4,5
E (corsa-stroke >25÷50)	0	8,5	8,5	42,5	36	34,5	29,5
E (corsa-stroke 75÷200)	0	6,5	6,5	17,5	11	21	16
E (corsa-stroke 250)	-						
FA	8	10	10	10	10	15	15
FB	5	6	6	12	12	13	13
G	30	36	42	48	54	64	78
GA	11	11,5	11,5	12	15	15	15,5
GB	8	9	10	9	12	12	13,5
H	64	84	94	113	121	149	163
HA	M4	M5	M5	M6	M6	M8	M10
HB	32,5	41,5	46,5	56	60	74	81
HC	32	42,5	47,5	57	61	75	82
J	15	18	21	24	27	32	39
K	15	18	21	24	27	32	39
L	22	24	30	34	40	46	58
MM	M5	M5	M6	M8	M8	M10	M10
ML	12	13	15	16	16	20	22
NN	M5	M5	M6	M8	M8	M10	M10
OA	4,2	5,2	5,2	6,5	6,5	8,5	8,5
OB	8	9,5	9,5	11	11	14	14
OL	4,5	5,5	5,5	7,5	7,5	9	9
P	M5	G1/8	G1/8	G1/8	G1/8	G1/4	G1/4
PA+	40	38,5	37,5	31,5	38	34	38
PB	10	10,5	13,5	16	18	21,5	28
PW	19	25	30	35,5	39,5	47	58
Q	16	18	26	30	30	40	50
R	54	70	78	96	104	130	130
S	25	30	40	45	45	60	70
T	62	81	91	110	118	146	158
U	46	54	64	78	86	110	124
VA	56	72	82	98	106	130	142
VB	38	44	50	63	72	92	110
VC	10,5	12,5	15	19,5	25	33	34
WA (corsa-stroke 0÷75)	44	44	44	48	48	48	52
WA (corsa-stroke 100÷175)	110	120	120	124	124	124	128
WA (corsa-stroke 200)	-	200	200	200	200	200	200
WA (corsa-stroke 250)	-						
WB (corsa-stroke 0÷75)	27	39	39	45	46	48	50
WB (corsa-stroke 100÷175)	60	77	77	83	84	86	88
WB (corsa-stroke 200)	-	117	117	121	122	124	124
WB (corsa-stroke 250)	-						
X ±0,02	24	28	34	42	50	66	80
oXA H9	3	3	4	4	4	5	5
XB	3,5	3,5	4,5	4,5	4,5	6	6
XC	3	3	3	3	3	4	4
XL	6	6	6	6	6	8	8
YY	M5	M6	M6	M8	M8	M10	M10
YL	10	12	12	16	16	20	22
Z	5	17	17	21	22	24	24
a	4,4	5,4	5,4	6,5	6,5	8,5	11
b	7,4	8,4	8,4	10,5	10,5	13,5	17,8
c	3,7	4,5	4,5	5,5	5,5	7,5	10
d	3,5	3,6	3,8	4,5	5	5,5	8
e	6,7	8,6	9	10,5	10,5	14,5	19,5

SERIE

E

D.E.M. CON CUSCINETTI A RICIRCOLO DI SFERE AMMORTIZZATO

D.A.M. CUSHIONED WITH RECIRCULATING BALL BEARINGS

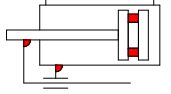

**CAVA SENSORE A T
T-SLOT FOR SENSOR**

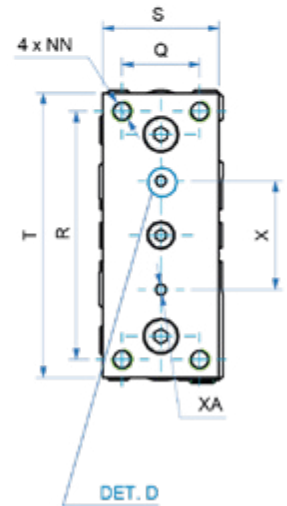
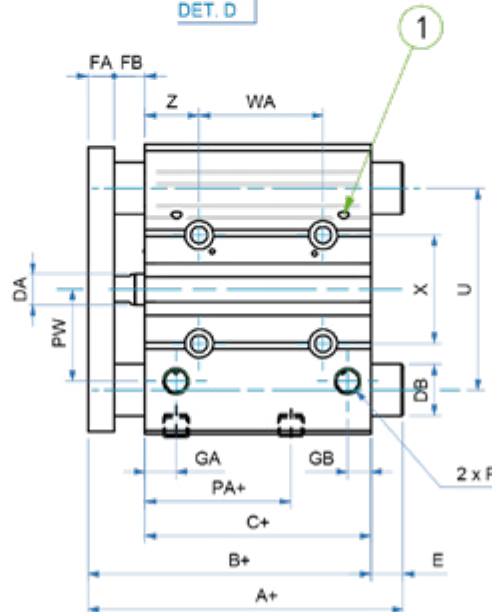
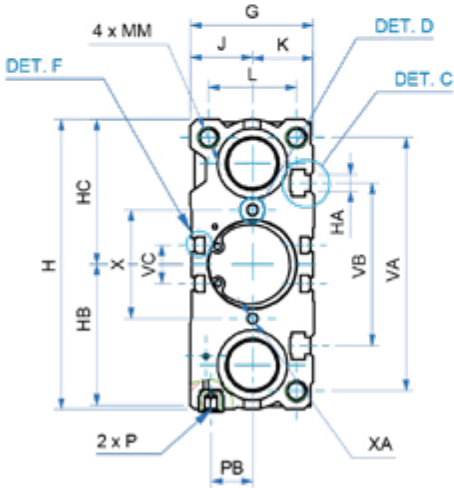
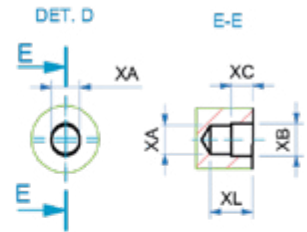
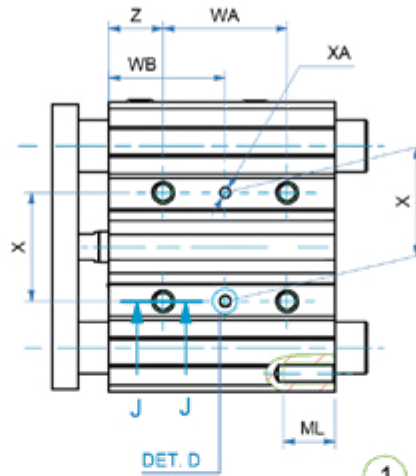
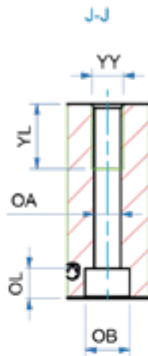
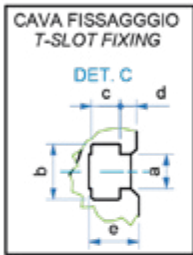
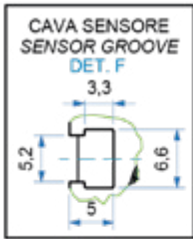

① Vite regolazione ammortizzo - Cushioning adjustment screw

9 CORSE STANDARD - STANDARD STROKES

016	25 - 50 - 75 - 100
020	25 - 50 - 75 - 100 - 125 - 150 - 175 - 200 - 250
025	25 - 50 - 75 - 100 - 125 - 150 - 175 - 200 - 250
032	25 - 50 - 75 - 100 - 125 - 150 - 175 - 200 - 250
040	25 - 50 - 75 - 100 - 125 - 150 - 175 - 200 - 250
050	25 - 50 - 75 - 100 - 125 - 150 - 175 - 200 - 250
063	25 - 50 - 75 - 100 - 125 - 150 - 175 - 200 - 250

!!!: Le corse intermedie della versione ammortizzata non sono realizzabili (per ulteriori informazioni contattare l'ufficio commerciale)

Intermediate strokes of versions with cushioning are not possible (for further information, please contact our sales department)

Ø	16	20	25	32	40	50	63
A+ (corsa-stroke 0÷25)	71	95	100,5	84,5	91	97	102
A+ (corsa-stroke 50)	71	80	85,5	123	123	127,5	127,5
A+ (corsa-stroke 75)	71	80	85,5	98	98	114	114
A+ (corsa-stroke 100)	71	99	104,5	115,5	115,5	159	159
A+ (corsa-stroke >125)	-	104	104,5	118	118	134	134
B+	71	78	78,5	84,5	91	97	102
C+	58	62	62,5	62,5	69	69	74
øDA	8	10	10	12	12	16	16
øDB	8	12	14	20	20	25	25
E (corsa-stroke 0÷25)	0	17	22	0	0	0	0
E (corsa-stroke 50)	0	2	7	38,5	32	30,5	25,5
E (corsa-stroke 75)	0	2	7	13,5	7	17	12
E (corsa-stroke 100)	0	21	26	31	24,5	62	57
E (corsa-stroke >125)	-	26	26	33,5	27	37	32
FA	8	10	10	10	10	15	15
FB	5	6	6	12	12	13	13
G	30	36	42	48	54	64	78
GA	11	11,5	11,5	12	15	15	15,5
GB	8	9	10	9	12	12	13,5
H	64	84	94	113	121	149	163
HA	M4	M5	M5	M6	M6	M8	M10
HB	32,5	41,5	46,5	56	60	74	81
HC	32	42,5	47,5	57	61	75	82
J	15	18	21	24	27	32	39
K	15	18	21	24	27	32	39
L	22	24	30	34	40	46	58
MM	M5	M5	M6	M8	M8	M10	M10
ML	12	13	15	16	16	20	22
NN	M5	M5	M6	M8	M8	M10	M10
OA	4,2	5,2	5,2	6,5	6,5	8,5	8,5
OB	8	9,5	9,5	11	11	14	14
OL	4,5	5,5	5,5	7,5	7,5	9	9
P	M5	G1/8	G1/8	G1/8	G1/8	G1/4	G1/4
PA+	40	38,5	37,5	31,5	38	34	38
PB	10	10,5	13,5	16	18	21,5	28
PW	19	25	30	35,5	39,5	47	58
Q	16	18	26	30	30	40	50
R	54	70	78	96	104	130	130
S	25	30	40	45	45	60	70
T	62	81	91	110	118	146	158
U	46	54	64	78	86	110	124
VA	56	72	82	98	106	130	142
VB	38	44	50	63	72	92	110
VC	10,5	12,5	15	19,5	25	33	34
WA (corsa-stroke 0÷75)	44	44	44	48	48	48	52
WA (corsa-stroke 100÷175)	110	120	120	124	124	124	128
WA (corsa-stroke 200)	-	200	200	200	200	200	200
WB (corsa-stroke 0÷75)	27	39	39	45	46	48	50
WB (corsa-stroke 100÷175)	60	77	77	83	84	86	88
WB (corsa-stroke 200)	-	117	117	121	122	124	124
X ±0,02	24	28	34	42	50	66	80
øXA H9	3	3	4	4	4	5	5
XB	3,5	3,5	4,5	4,5	4,5	6	6
XC	3	3	3	3	3	4	4
XL	6	6	6	6	6	8	8
YY	M5	M6	M6	M8	M8	M10	M10
YL	10	12	12	16	16	20	22
Z	5	17	17	21	22	24	24
a	4,4	5,4	5,4	6,5	6,5	8,5	11
b	7,4	8,4	8,4	10,5	10,5	13,5	17,8
c	3,7	4,5	4,5	5,5	5,5	7,5	10
d	3,5	3,6	3,8	4,5	5	5,5	8
e	6,7	8,6	9	10,5	10,5	14,5	19,5

SENSORI MAGNETICI (versione E1 CAVA T)

MAGNETIC SENSORS (E1 version T-SLOT)

CARATTERISTICHE - CHARACTERISTICS				
CODICE - CODE	36.SEN06 36.SEN06.L6	36.SEN07	36.SEN08	36.SEN09 36.SEN09.L6 36.SEN09.L10
TIPO - TYPE	REED	REED	ELETTRONICO ELECTRONIC	ELETTRONICO ELECTRONIC
Modello elettrico - Electrical design	AC/DC PNP/NPN	AC/DC PNP/NPN	DC PNP	DC PNP
Funzione dell'uscita - Output	NO	NO	NO	NO
Tensione di esercizio - Operating voltage	[V] 5...120 AC/DC	5...60 DC / 5...50 AC	10...30 DC	10...30 DC
Capacità di corrente - Current rating	[mA] 100*	100*	100	100
Sensibilità di reazione - Magnetic sensitivity	[mT] 2,1	2,1	2,8	2,8
Velocità di passaggio - Travel speed	[m/s] > 10	> 10	> 10	> 10
Protezione da cortocircuito - Short-circuit proof	no	no	si - yes	si - yes
Protetto da inversione di polarità Reverse polarity protection	si - yes	si - yes	si - yes	si - yes
Resistente a sovraccarico - Overload protection	no	no	si - yes	si - yes
Caduta di tensione - Voltage drop	[V] < 5	< 5	< 2,5	< 2,5
Isteresi - Hysteresis	1	1	< 1,5	< 1,5
Riproducibilità - Repeatability	[mm] ± 0,2	± 0,2	< 0,2	< 0,2
Corrente assorbita - Current consumption	[mA] -	-	< 10	< 10
Tempo di commutazione - Make time	[ms] ≤ 0,6	≤ 0,6	-	-
Tempo di riapertura - Fall time	[ms] ≤ 0,1	≤ 0,1	-	-
Potenza max - Switching power max	[W] 10	10	-	-
Cicli di commutazione con connessione a PLC Switching cycles when connected to PLC	[mln] ≤ 40	≤ 40	-	-
Frequenza di commutazione - Switching frequency	[Hz] 1.000	1.000	> 10.000	> 10.000
Temperatura ambiente - Ambient temperature	[°C] -25...70	-25...70	-25...80	-25...80
Grado/Classe di protezione - Protection	IP67, II	IP67, II	IP67, III	IP67, III
Materiale involucro - Housing material	PA (poliammide - polyamide)			
Materiale eccentrico di fissaggio - Fastening clamp	inox - stainless steel			
Indicazione della funzione Stato di commutazione Function display Switching status	LED	giallo - yellow		
Collegamento - Connection	cavo PUR - PUR cable 2x0,14 mm ² 2 m (.L6 = 6 m)	cavo PUR - PUR cable connettore M8- M8 connector 0,3 m	cavo PUR - PUR cable connettore M8- M8 connector 0,3 m	cavo PUR - PUR cable 3x0,14 mm ² 2 m (.L6 = 6 m .L10 = 10 m)
Peso - Weight	[g] 31,3 69	12	12,1	27,4 73,5 122,4

Accessori inclusi: Segnaposto in gomma, fascetta fermacavo - Accessories included: Rubber placeholder, cable clip

*: necessario circuito di protezione esterno per carico induttivo (valvola, relè, ecc...). - External protective circuit for inductive load (valve, contactor, etc...) necessary.

REED: nessuna funzione LED in caso di inversione di polarità nel funzionamento DC. - No LED function in case of polarity reversal in DC operation.

CONTATTO REED (2 FILI)

36.SEN06

36.SEN06.L6

REED CONTACT (2 WIRES)

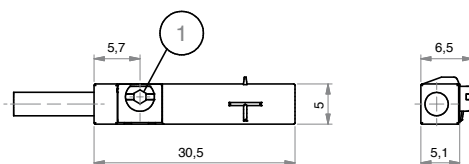

1= ECCENTRICO DI FISSAGGIO - FASTENING CLAMP

CABLAGGIO - WIRING

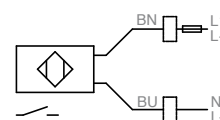

BN= MARRONE - BROWN
BU= BLU - BLUE

CONTATTO REED (CONNETTORE M8)

36.SEN07

REED CONTACT (M8 CONNECTOR)

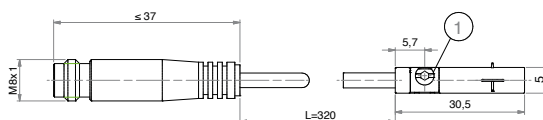

1= ECCENTRICO DI FISSAGGIO - FASTENING CLAMP

CABLAGGIO - WIRING

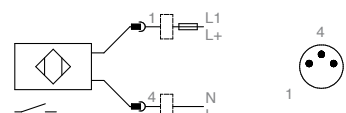

BN= MARRONE - BROWN
BU= BLU - BLUE

SERIE
E

CONTATTO PNP (CONNETTORE M8)

36.SEN08

PNP CONTACT (M8 CONNECTOR)

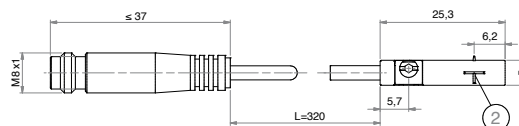

1= ECCENTRICO DI FISSAGGIO FASTENING CLAMP
2= SUPERFICIE ATTIVA SENSING FACE

CABLAGGIO - WIRING

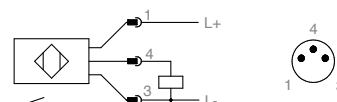

BN= MARRONE - BROWN
BU= BLU - BLUE

CONTATTO PNP (3 FILI)

36.SEN09

36.SEN09.L6

36.SEN09.L10

PNP CONTACT (3 WIRES)

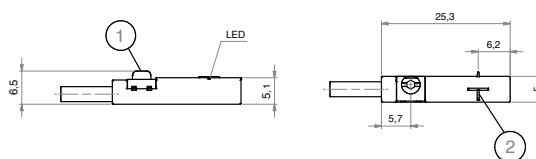

1= ECCENTRICO DI FISSAGGIO - FASTENING CLAMP
2= SUPERFICIE ATTIVA - SENSING FACE

CABLAGGIO - WIRING

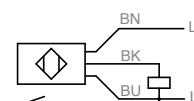

BK= NERO - BLACK
BN= MARRONE - BROWN
BU= BLU - BLUE

CAVO PROLUNGA (CONNETTORE M8)

EXTENSION CABLE (M8 CONNECTOR)

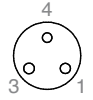
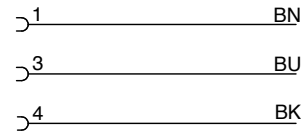
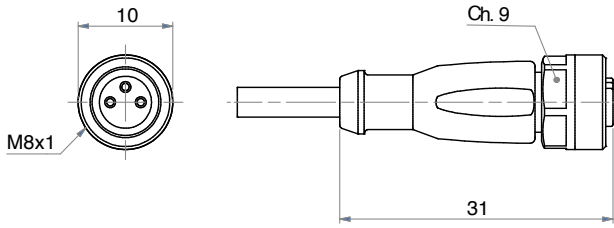

SENSORI MAGNETICI (versione E CAVA C)

MAGNETIC SENSORS (E version C-SLOT)

CARATTERISTICHE - CHARACTERISTICS					
CODICE - CODE		36.SEN26	36.SEN27	36.SEN28	36.SEN29
TIPO - TYPE		ELETTRONICO ELECTRONIC	ELETTRONICO ELECTRONIC	ELETTRONICO ELECTRONIC	ELETTRONICO ELECTRONIC
Modello elettrico - Electrical design		DC PNP	DC PNP	DC PNP	DC PNP
Funzione dell'uscita - Output		NO	NO	NO	NO
Tensione di esercizio - Operating voltage	[V]	10...30 DC	10...30 DC	10...30 DC	10...30 DC
Capacità di corrente - Current rating	[mA]	100	100	100	100
Sensibilità di reazione - Magnetic sensitivity	[mT]	2,8	2,8	2,8	2,8
Velocità di passaggio - Travel speed	[m/s]	> 10	> 10	> 10	> 10
Protezione da cortocircuito - Short-circuit proof		si - yes	si - yes	si - yes	si - yes
Protetto da inversione di polarità Reverse polarity protection		si - yes	si - yes	si - yes	si - yes
Resistente a sovraccarico - Overload protection		si - yes	si - yes	si - yes	si - yes
Caduta di tensione - Voltage drop	[V]	< 4,5	< 4,5	< 2,5	< 2,5
Isteresi - Hysteresis		< 0,12	< 0,12	< 1,5	< 1,5
Riproducibilità - Repeatability	[mm]	< 0,2	< 0,2	< 0,2	< 0,2
Corrente assorbita - Current consumption	[mA]	< 10	< 10	< 10	< 10
Frequenza di commutazione - Switching frequency	[Hz]	4.000	4.000	10.000	10.000
Temperatura ambiente - Ambient temperature	[°C]	-25...85	-25...85	-25...85	-25...85
Grado/Classe di protezione - Protection		IP65; IP67	IP65; IP67	IP65; IP67	IP65; IP67
Materiale involucro - Housing material		PA (poliammide - polyamide)			
Materiale eccentrico di fissaggio - Fastening clamp		inox - stainless steel			
Indicazione della funzione Stato di commutazione Function display Switching status	LED	giallo - yellow			
Collegamento - Connection		cavo PUR PUR cable / 2 m 2x0,14 mm ²	cavo PUR PUR cable / 0,3 m spina M8 m8 connector	cavo PUR PUR cable / 0,3 m spina M8 m8 connector	cavo PUR PUR cable / 2 m 3x0,14 mm ²
Peso - Weight	[g]	19	9,8	9,7	17,6

SERIE
E

ADATTATORE DA CAVA T A CAVA C

36.ADATC

T-SLOT ADAPTER FOR C-SLOT

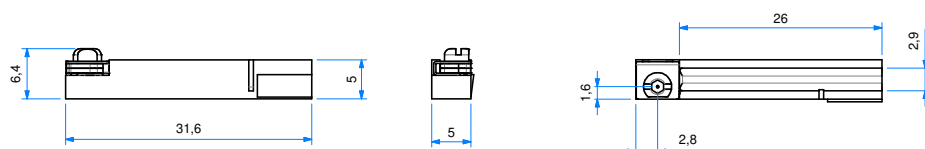

MATERIALE:
ZINCO PRESSOFUSO;
BRIGLIA DI FISSAGGIO: ACCIAIO INOX
MATERIAL:
DIECAST ZINC;
FIXING ELEMENT: STAINLESS STEEL

CONTATTO PNP (2 FILI)

PNP CONTACT (2 WIRES)

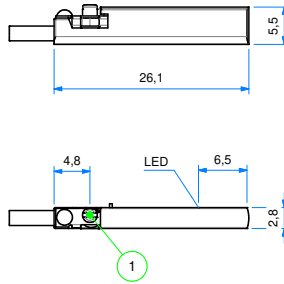

1= ECCENTRICO DI FISSAGGIO - FASTENING CLAMP

CABLAGGIO - WIRING

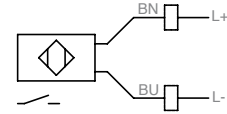

BN= MARRONE - BROWN
BU= BLU - BLUE

CONTATTO PNP (CONNETTORE M8)

PNP CONTACT (M8 CONNECTOR)

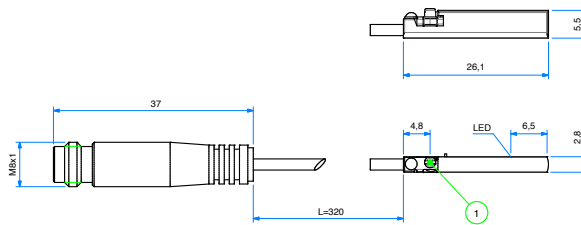

1= ECCENTRICO DI FISSAGGIO - FASTENING CLAMP

CABLAGGIO - WIRING

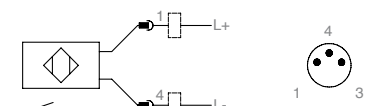

BN= MARRONE - BROWN
BU= BLU - BLUE

CONTATTO PNP (CONNETTORE M8)

PNP CONTACT (M8 CONNECTOR)

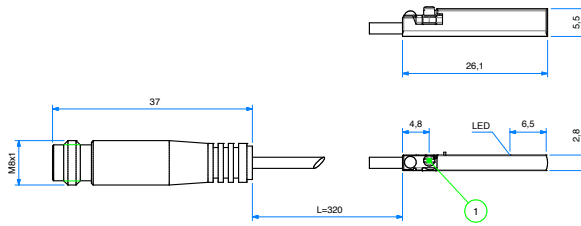

1= ECCENTRICO DI FISSAGGIO - FASTENING CLAMP

CABLAGGIO - WIRING

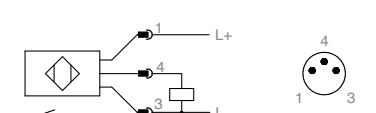

BN= MARRONE - BROWN
BU= BLU - BLUE

CONTATTO PNP (3 FILI)

PNP CONTACT (3 WIRES)

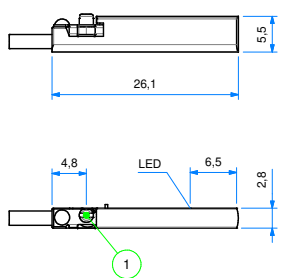

1= ECCENTRICO DI FISSAGGIO - FASTENING CLAMP

CABLAGGIO - WIRING

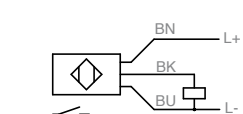



BK= NERO - BLACK
BN= MARRONE - BROWN
BU= BLU - BLUE



SENSORI MAGNETICI ATEX

ATEX MAGNETIC SENSORS

CARATTERISTICHE - CHARACTERISTICS	36.SEN32A.L6	36.SEN33A
TIPO - TYPE	ELETTRONICO - ELECTRONIC	ELETTRONICO - ELECTRONIC
Modello elettrico - Electrical design	DC PNP	DC PNP
Funzione dell'uscita - Output	NO	NO
Tensione di esercizio - Operating voltage [V]	10...30 DC	10...30 DC
Capacità di corrente - Current rating [mA]	100	100
Sensibilità di reazione - Magnetic sensitivity [mT]	2	2,8
Velocità di passaggio - Travel speed [m/s]	> 10	> 10
Protezione da cortocircuito - Short-circuit proof	si - yes	si - yes
Protetto da inversione di polarità - Reverse polarity protection	si - yes	si - yes
Resistente a sovraccarico - Overload protection	si - yes	si - yes
Caduta di tensione - Voltage drop [V]	< 2,5	< 2,5
Isteresi - Hysteresis	1	< 1,5
Riproducibilità - Repeatability [mm]	< 0,2	< 0,2
Corrente assorbita - Current consumption [mA]	< 10	< 10
Ritardo alla disponibilità - Power-on delay time [ms]	< 30	< 30
Frequenza di commutazione - Switching frequency [Hz]	6.000	10.000
Temperatura ambiente - Ambient temperature [°C]	-20...60	-25...60
Grado/Classe di protezione - Protection	IP 65/IP 67	IP 65/IP 67
Contrassegno - Marking of the unit	 II 3D Ex tc IIIC T125°C Dc X  II 3G Ex nA IIC T4 Gc X	 II 3D Ex tc IIIC T125°C Dc X
Materiale involucri - Housing material	PA (poliammide-polyamide)	PA (poliammide-polyamide)
Materiale eccentrico di fissaggio - Fastening clamp	inox - stainless steel	inox - stainless steel
Indicazione della funzione Stato di commutazione Function display Switching status	LED giallo - yellow	giallo - yellow
Collegamento - Connection	cavo PVC - PVC cable 3x0,14 mm ²	cavo PVC - PVC cable connettore M12 - M12 connector
Lunghezza cavo - Cable length	6 m	0,3 m
Peso - Weight [g]	103,3	52,4

Accessori inclusi - Accessories included: Segnaposto in gomma, fascetta fermacavo - Rubber placeholder, cable clip

SERIE

E



36.SEN32A.L6

CONTATTO PNP (3 FILI)

PNP CONTACT (3 WIRES)

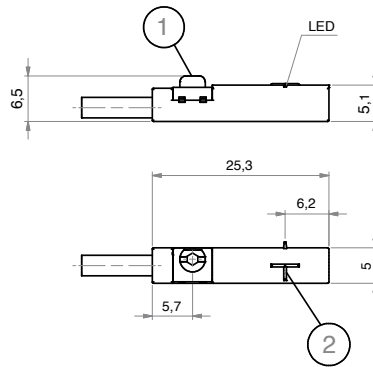

1= ECCENTRICO DI FISSAGGIO - FASTENING CLAMP
2= SUPERFICIE ATTIVA - SENSING FACE

CABLAGGIO - WIRING

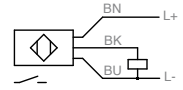

BK= NERO - BLACK
BN= MARRONE - BROWN
BU= BLU - BLUE



36.SEN33A

CONTATTO PNP (CONNETTORE M12)

PNP CONTACT (M12 CONNECTOR)

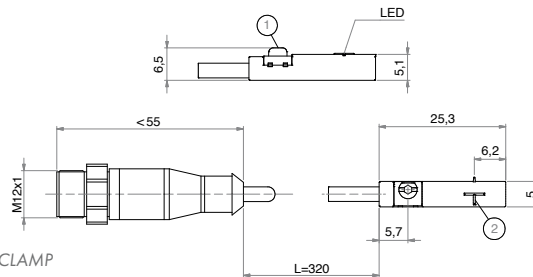

1= ECCENTRICO DI FISSAGGIO - FASTENING CLAMP
2= SUPERFICIE ATTIVA - SENSING FACE

CABLAGGIO - WIRING

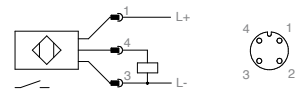

BK= NERO - BLACK
BN= MARRONE - BROWN
BU= BLU - BLUE



36.CAVA

CAVO PROLUNGA (CONNETTORE M12)

EXTENSION CABLE (M12 CONNECTOR)

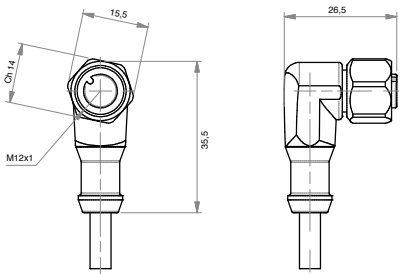

CABLAGGIO - WIRING

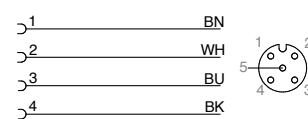

BK= NERO - BLACK
BN= MARRONE - BROWN

BU= BLU - BLUE
WH= BIANCO - WHITE

DIMENSIONI - DIMENSIONS		36.CAV5A.M12	36.CAV10A.M12
Modello elettrico - Electrical design		AC/DC	AC/DC
Tensione di esercizio - Operating voltage	[V]	60 AC / 60 DC	60 AC / 60 DC
Capacità di corrente - Current rating	[A]	2	2
Modello - Design		ad angolo - angled	ad angolo - angled
Temperatura ambiente - Ambient temperature	[°C]	-20...60	-20...60
Grado/Classe di protezione - Protection		IP67/IP68 - IP69K fuori dalla zona esplosiva - outside hazardous areas	
Contrassegno - Marking of the unit		II 3G Ex nA IIC Gc - II 2D Ex tb IIIC Db IP65/IP67	
Materiale corpo - Body material: Involucro - Housing		TPU arancione - orange TPU	TPU arancione - orange TPU
Guarnizione - Sealing		viton	viton
Materiale dado - Nut material		inox - stainless steel (1.4404 / 316L)	inox - stainless steel (1.4404 / 316L)
Coppia di serraggio per nodo nocciolo Tightening torque for knurled nut	[Nm]	0,2...1,5	0,2...1,5
Collegamento - Connection		cavo PUR - PUR cable / 5 m; 4 x 0,34 mm ² (42 x Ø 0,1 mm); Ø 4,9 mm; senza alogeno - alogen free	cavo PUR - PUR cable / 10 m; 4 x 0,34 mm ² (42 x Ø 0,1 mm); Ø 4,9 mm; senza alogeno - alogen free
Colore della guaina - Sheath colour		nero - black	nero - black