

# GU LINE

Innesti Rapidi  
Couplings  
Coupleurs  
Kupplungen



1	2	3	4	5	
Corpo Body Corps Körper	Otturatore Valve Clapet Ventil	Molle Springs Ressorts Feder	Guarnizioni Seals Joint d'étanchéité Dichtung	Sfere Balls Billes Kugel	Innesti Plugs Embouts Stecker
Ottone UNI EN 12164 CW614N Nichelato Brass UNI EN 12164 CW614N Nickel plated Laiton UNI EN 12164 CW614N Nickelé Ms Vernickelt UNI EN 12164 CW614N	Ottone UNI EN 12164 CW614N Brass UNI EN 12164 CW614N Laiton UNI EN 12164 CW614N Messing UNI EN 12164 CW614N	Acciaio Inox AISI 302 Stainless Steel AISI 302 Acier Inox AISI 302 Edelstahl AISI 302	NBR NBR NBR NBR	Acciaio Inox AISI 420 Stainless Steel AISI 420 Acier Inox AISI 420 Edelstahl AISI 420	Ottone UNI EN 12164 CW614N Nichelato Brass UNI EN 12164 CW614N Nickel plated Laiton UNI EN 12164 CW614N Nickelé Ms Vernickelt UNI EN 12164 CW614N



Scala 1:1  
Scale 1:1  
Echelle 1:1  
Maßstab 1:1

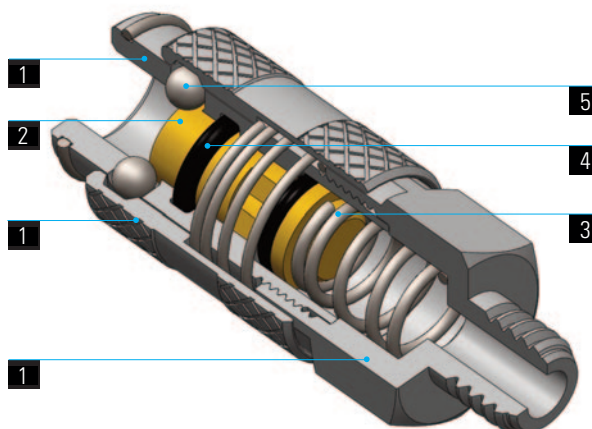

Campi di applicazione:  
Impianti pneumatici.

Application fields:  
Pneumatic circuits.

Domaines d'application:  
Circuits pneumatiques.

Anwendungsbereiche:  
Pneumatische Anlagen.

### GU 20-11

Innesto rapido con filetto maschio

Male coupling

Coupleur mâle

Einschraubkupplung

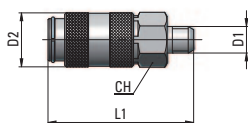

Tipo	D1	D2	L1	CH	g $\Delta$
11 00 M5	M5x0,8	10	27	9	10
11 00 18	G1/8	10	29	12	14

### GU 20-12

Innesto rapido con filetto femmina

Female coupling

Coupleur femelle

Aufschraubkupplung

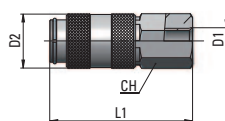

Tipo	D1	D2	L1	CH	g $\Delta$
12 00 M5	M5x0,8	10	27	9	11
12 00 18	G1/8	10	29	12	15

## GU 20-13

Innesto rapido con portagomma

Coupling with hose connection

Coupleur avec douille cannelée

Kupplung mit Schlauchtülle

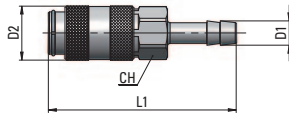

Tipo	Ø: Tubo	D <sub>1</sub>	D <sub>2</sub>	L <sub>1</sub>	CH	g
13 03 00	3	3,6	10	36	9	9
13 04 00	4	4,6	10	36	9	10

## GU 20-15

Innesto rapido con calzamento

Coupling with Nut fitting

Coupleur avec raccord à écrou

Kupplung mit Überwurfverschraubung

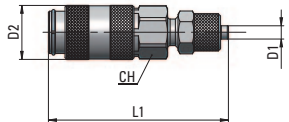

Tipo	D <sub>1</sub>	D <sub>2</sub>	L <sub>1</sub>	CH	g
15 04 00	4x2,5	10	33	9	11
15 06 00	6x4	10	35	9	13

## GU 20-20

Innesto con filetto maschio

Male plug

Embout mâle

Einschraubverschlußnippel

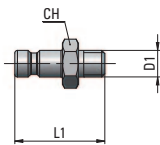

Tipo	D <sub>1</sub>	L <sub>1</sub>	CH	g
20 00 M5	M5x0,8	17	8	3
20 00 18	G1/8	20	12	7

## GU 20-21

Innesto con filetto femmina

Female plug

Embout femelle

Aufschraubverschlußnippel

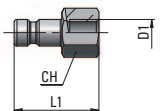

Tipo	D <sub>1</sub>	L <sub>1</sub>	CH	g
21 00 M5	M5x0,8	16	8	3
21 00 18	G1/8	19	12	6,5

## GU 20-22

Innesto con portagomma

Plug with hose connection

Embout avec douille cannelée

Schlauchtülle

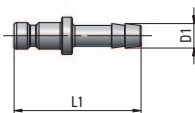

Tipo	Ø: Tubo	D <sub>1</sub>	L <sub>1</sub>	g
22 03 00	3	3,6	24	2
22 04 00	4	4,6	24	2,5

## GU 20-23

Innesto con raccordo a calzamento

Plug with Nut Fitting

Embout avec raccord à écrou

Verschlußtülle mit Überwurfmutter

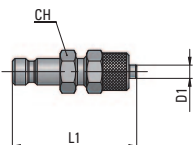

Tipo	D <sub>1</sub>	L <sub>1</sub>	CH	g
23 04 00	4x2,5	23	7	4
23 06 00	6x4	25	8	6

1	2	3	4	5	
Corpo Body Corps Körper	Otturatore Valve Clapet Ventil	Molle Springs Ressorts Feder	Guarnizioni Seals Joint d'étanchéité Dichtung	Sfere Balls Billes Kugel	Innesti Plugs Embouts Stecker
Ottone UNI EN 12164 CW614N Nichelato Brass UNI EN 12164 CW614N Nickel plated Laiton UNI EN 12164 CW614N Nickelé Ms Vernickelt UNI EN 12164 CW614N	Ottone UNI EN 12164 CW614N Nichelato Brass UNI EN 12164 CW614N Nickel plated Laiton UNI EN 12164 CW614N Nickelé Ms Vernickelt UNI EN 12164 CW614N	Acciaio Inox AISI 302 Stainless Steel AISI 302 Acier Inox AISI 302 Edelstahl AISI 302	NBR NBR NBR NBR	Acciaio Inox AISI 420 Stainless Steel AISI 420 Acier Inox AISI 420 Edelstahl AISI 420	Ottone UNI EN 12164 CW614N Nichelato Brass UNI EN 12164 CW614N Nickel plated Laiton UNI EN 12164 CW614N Nickelé Ms Vernickelt UNI EN 12164 CW614N



-20°C ÷ 70°C



0 ÷ 15 bar



5 mm



600 NI/min  
(6 bar - Δp = 1bar)



RoHS





Scala 1:1  
Scale 1:1  
Echelle 1:1  
Maßstab 1:1

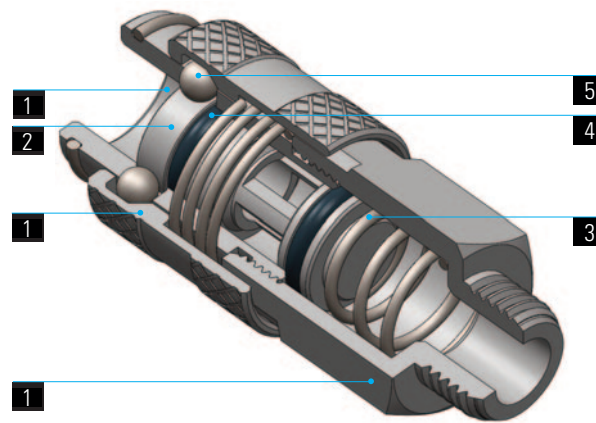

Campi di applicazione:  
Impianti pneumatici.

Application fields:  
Pneumatic circuits.

Domaines d'application:  
Circuits pneumatiques.

Anwendungsbereiche:  
Pneumatische Anlagen.

### GU 21-11

Innesto rapido con filetto maschio

Male coupling

Coupleur mâle

Einschraubkupplung

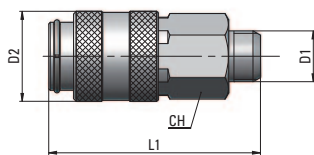

Tipo	D1	D2	L1	CH	g $\Delta$
11 00 18	G1/8	16	40	14	27
11 00 14	G1/4	16	40	17	37

### GU 21-12

Innesto rapido con filetto femmina

Female coupling

Coupleur femelle

Aufschraubkupplung

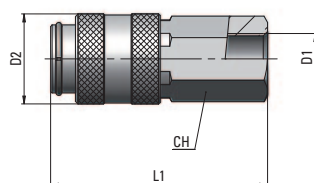

Tipo	D1	D2	L1	CH	g $\Delta$
12 00 18	G1/8	16	40	14	35
12 00 14	G1/4	16	41	17	44,5

## GU 21-13

Innesto rapido con portagomma

Coupling with hose connection

Coupleur avec douille cannelée

Kupplung mit Schlauchtülle

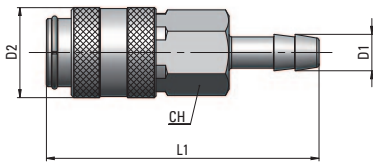

Tipo	Ø: Tubo	D <sub>1</sub>	D <sub>2</sub>	L <sub>1</sub>	CH	g $\Delta$
13 04 00	4	5	16	50	14	25
13 06 00	6	7	16	50	14	32

## GU 21-15

Innesto rapido con calzamento

Coupling with Nut fitting

Coupleur avec raccord à écrou

Kupplung mit Überwurfverschraubung

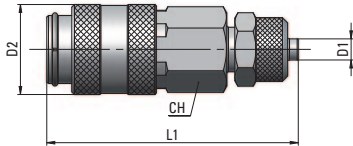

Tipo	D <sub>1</sub>	D <sub>2</sub>	L <sub>1</sub>	CH	g $\Delta$
15 06 00	6x4	16	47	14	37
15 08 00	8x6	16	48	14	38

## GU 21-20

Innesto con filetto maschio

Male plug

Embout mâle

Einschraubverschlußsnippel

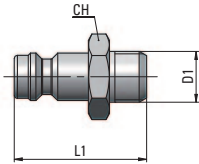

Tipo	D <sub>1</sub>	L <sub>1</sub>	CH	g $\Delta$
20 00 18	G1/8	25	14	11
20 00 14	G1/4	27	17	19

## GU 21-21

Innesto con filetto femmina

Female plug

Embout femelle

Aufschraubverschlußsnippel

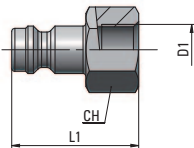

Tipo	D <sub>1</sub>	L <sub>1</sub>	CH	g $\Delta$
21 00 18	G1/8	25	14	13
21 00 14	G1/4	27	17	19

## GU 21-22

Innesto con portagomma

Hose connection plug

Embout avec douille cannelée

Schlauchtülle

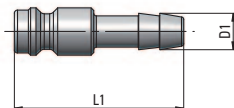

Tipo	Ø: Tubo	D <sub>1</sub>	L <sub>1</sub>	g $\Delta$
22 04 00	4	5	32	6
22 06 00	6	7	32	6,5

## GU 21-23

Innesto con raccordo a calzamento

Plug with Nut Fitting

Embout avec raccord à écrou

Verschlußstülle mit Überwurfmutter

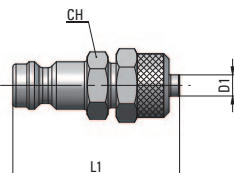

Tipo	D <sub>1</sub>	L <sub>1</sub>	CH	g $\Delta$
23 06 00	6x4	32	11	15
23 08 00	8x6	33	13	18

## GU 21-24

Innesto con molla di protezione

Plug with hose protection spring

Embout avec ressort protection tube

Verschlussstübe mit Knickschutzfeder

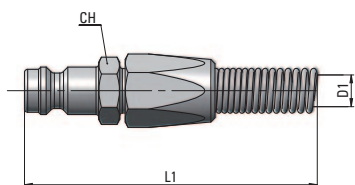

Tipo	D1	L1	CH	g $\Delta$
24 06 00	6x4	110	11	24
24 08 00	8x6	120	13	31

1	2	3	4	5	
Corpo Body Corps Körper	Otturatore Valve Clapet Ventil	Molle Springs Ressorts Feder	Guarnizioni Seals Joint d'étanchéité Dichtung	Sfere Balls Billes Kugel	Innesti Plugs Embouts Stecker
Ottone UNI EN 12164 CW614N Nichelato Brass UNI EN 12164 CW614N Nickel plated Laiton UNI EN 12164 CW614N Nickelé Ms Vernickelt UNI EN 12164 CW614N	Ottone UNI EN 12164 CW614N Nichelato Brass UNI EN 12164 CW614N Nickel plated Laiton UNI EN 12164 CW614N Nickelé Ms Vernickelt UNI EN 12164 CW614N	Acciaio Inox AISI 302 Stainless Steel AISI 302 Acier Inox AISI 302 Edelstahl AISI 302	NBR NBR NBR NBR	Acciaio Inox AISI 420 Stainless Steel AISI 420 Acier Inox AISI 420 Edelstahl AISI 420	Ottone UNI EN 12164 CW614N Nichelato Brass UNI EN 12164 CW614N Nickel plated Laiton UNI EN 12164 CW614N Nickelé Ms Vernickelt UNI EN 12164 CW614N

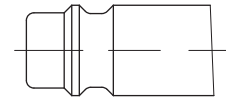
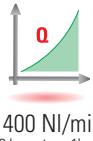

Profilo Europeo  
European Profile  
Profil européen  
Europäisches Profil

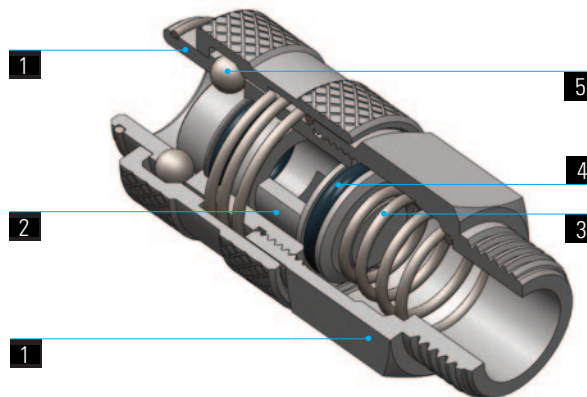

Campi di applicazione:  
Impianti pneumatici.

Application fields:  
Pneumatic circuits.

Domaines d'application:  
Circuits pneumatiques.

Anwendungsbereiche:  
Pneumatische Anlagen.

### GU 26-11

Innesto rapido con filetto maschio Male coupling

Coupleur mâle

Einschraubkupplung

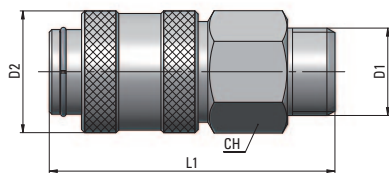

Tipo	D1	D2	L1	CH	g
11 00 14	G1/4	23	54	19	82
11 00 38	G3/8	23	54	20	89
11 00 12	G1/2	23	54	24	107

### GU 26-12

Innesto rapido con filetto femmina Female coupling

Coupleur femelle

Aufschraubkupplung

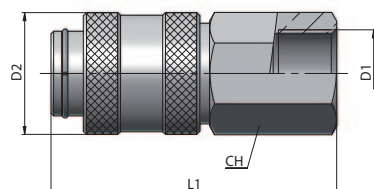

Tipo	D1	D2	L1	CH	g
12 00 14	G1/4	23	54	19	91
12 00 38	G3/8	23	54	20	90,5
12 00 12	G1/2	23	54	24	105

## GU 26-13

Innesto rapido con portagomma

Coupling with hose connection

Coupleur avec douille cannelée

Kupplung mit Schlauchtülle

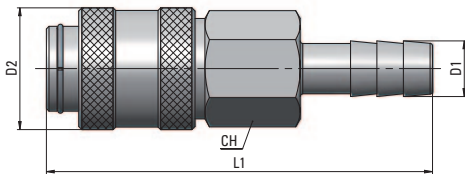

Tipo	Ø: Tubo	D <sub>1</sub>	D <sub>2</sub>	L <sub>1</sub>	CH	g
13 06 00	6	7,5	23	73	19	89
13 09 00	9	10,5	23	73	19	91
13 13 00	13	14,5	23	73	19	94

## GU 26-15

Innesto rapido con calzamento

Coupling with Nut fitting

Coupleur avec raccord à écrou

Kupplung mit Überwurfverschraubung

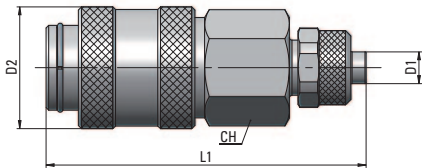

Tipo	D <sub>1</sub>	D <sub>2</sub>	L <sub>1</sub>	CH	g
15 08 00	8x6	23	60	19	89
15 10 00	10x8	23	61	19	103

## GU 26-20

Innesto con filetto maschio

Male plug

Embout mâle

Einschraubverschußnippel

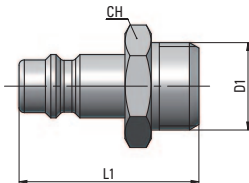

Tipo	D <sub>1</sub>	L <sub>1</sub>	CH	g
20 00 14	G1/4	33	17	22
20 00 38	G3/8	34	20	30
20 00 12	G1/2	37	24	50

## GU 26-21

Innesto con filetto femmina

Female plug

Embout femelle

Aufschraubverschußnippel

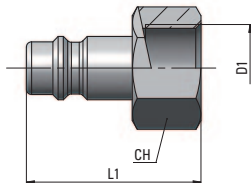

Tipo	D <sub>1</sub>	L <sub>1</sub>	CH	g
21 00 14	G1/4	33	17	24
21 00 38	G3/8	33	20	25
21 00 12	G1/2	36	24	40

## GU 26-22

Innesto con portagomma

Hose connection plug

Embout avec douille cannelée

Schlauchtülle

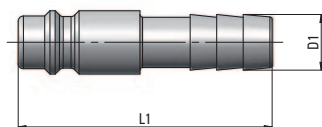

Tipo	Ø: Tubo	D <sub>1</sub>	L <sub>1</sub>	g
22 06 00	6	7,5	48	15
22 08 00	8	9,5	48	16
22 09 00	9	10,5	48	17
22 10 00	10	11,5	48	21
22 13 00	13	14,5	48	34

## GU 26-23

Innesto con raccordo a calzamento

Plug with Nut Fitting

Embout avec raccord à écrou

Verschußtülle mit Überwurfmutter

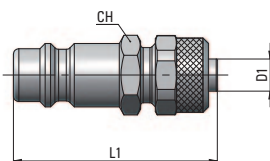

Tipo	D <sub>1</sub>	L <sub>1</sub>	CH	g
23 06 00	6x4	38	13	20
23 08 00	8x6	39	13	21
23 10 00	10x8	42	15	29



## GU 26-24

Innesto con molla di protezione

Plug with hose protection spring

Embout avec ressort protection tube

Verschlussstübe mit Knickschutzfeder

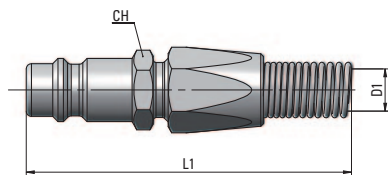

Tipo	D1	L1	CH	g $\Delta$
24 06 00	6x4	120	13	30
24 08 00	8x6	125	13	34
24 10 00	10x8	135	15	52,5

1	2	3	4	5	GU 11
Corpo Body Corps Körper	Otturatore Valve Clapet Ventil	Molle Springs Ressorts Feder	Guarnizioni Seals Joint d'étanchéité Dichtung	Sfere Balls Billes Kugel	Innesti Plugs Embouts Stecker
Ottone UNI EN 12164 CW614N Nichelato Brass UNI EN 12164 CW614N Nickel plated Laiton UNI EN 12164 CW614N Nickelé Ms Vernickelt UNI EN 12164 CW614N	Ottone UNI EN 12164 CW614N Nichelato Brass UNI EN 12164 CW614N Nickel plated Laiton UNI EN 12164 CW614N Nickelé Ms Vernickelt UNI EN 12164 CW614N	Acciaio Inox AISI 302 Stainless Steel AISI 302 Acier Inox AISI 302 Edelstahl AISI 302	NBR NBR NBR NBR	Acciaio Inox AISI 420 Stainless Steel AISI 420 Acier Inox AISI 420 Edelstahl AISI 420	Acciaio Nichelato Nickel plated steel Acier Nickelé Stahl Vernickelt

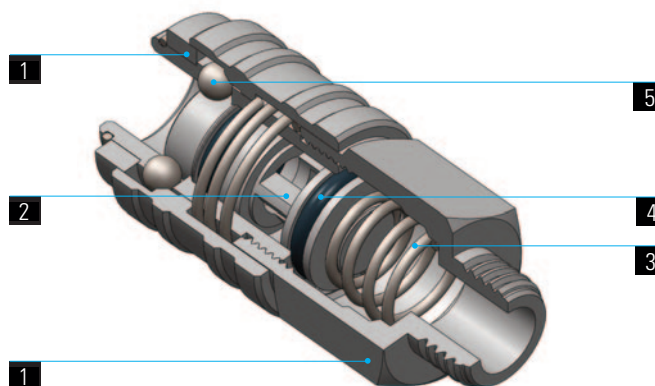

Intercambiabilità con i profili  
Suitable with following plugs profiles  
Interchangeable avec les suivants profils  
Austauschbar mit folgenden Profilen

Portata  
Flow rate  
Débit  
Durchfluß  
(6 bar - Δp = 1 bar)

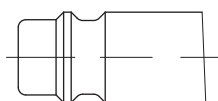

Profilo Europeo  
European Profile  
Profil européen  
Europäisches Profil

820

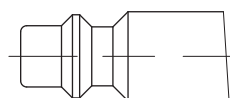

Profilo ISO 6150 B  
ISO 6150 B Profile  
Profil ISO 6150 B  
ISO 6150 B Profil

715

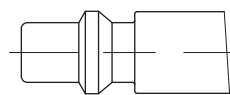

Profilo Svedese  
Standard Swedish Profile  
Profil Standard Suédois  
Standard schwedisches Profil

725

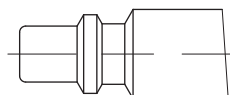

Profilo Italiano  
Standard Italian Profile  
Profil Standard Italien  
Standard Italienisches Profil

670

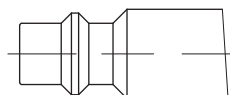

Profilo MIL C4109  
MIL C4109 Profile  
Profil MIL C4109  
MIL C4109 Profil

715

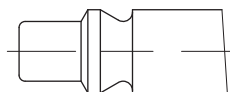

Profilo ARO 210  
ARO 210 Profile  
Profil ARO 210  
ARO 210 Profil

705

Scala 1:1 - Scale 1:1 - Echelle 1:1 - Maßstab 1:1

## GU 10-11

Innesto rapido con filetto maschio Male coupling

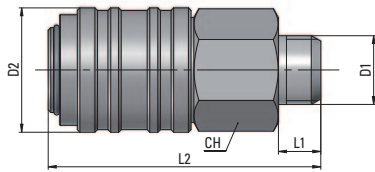

Coupleur mâle

Einschraubkupplung

Tipo	D1	D2	L1	L2	CH	g
11 00 14	G1/4	23,5	10	52	20	88
11 00 38	G3/8	23,5	11	52	20	92
11 00 12	G1/2	23,5	11	52	24	118

## GU 10-12

Innesto rapido con filetto femmina Female coupling

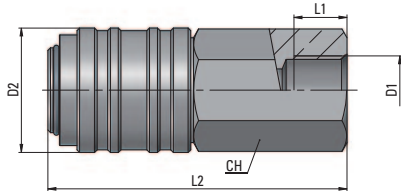

Coupleur femelle

Aufschraubkupplung

Tipo	D1	D2	L1	L2	CH	g
12 00 14	G1/4	23,5	10	57	20	109
12 00 38	G3/8	23,5	11	58	20	104
12 00 12	G1/2	23,5	11	60	24	134

## GU 10-13

Innesto rapido con portagomma Coupling with hose connection

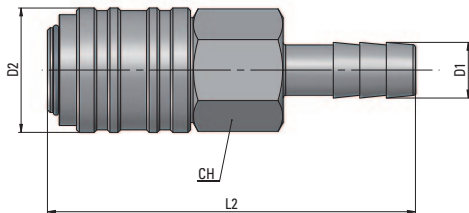

Coupleur avec douille cannelée

Kupplung mit Schlauchtülle

Tipo	Øi Tubo	D1	D2	L2	CH	g
13 06 00	6	7,5	23,5	70	20	92
13 09 00	9	10,5	23,5	70	20	93
13 13 00	13	14,5	23,5	70	20	107

## GU 11-20

Innesto Italia con filetto maschio Male plug, Italian profile

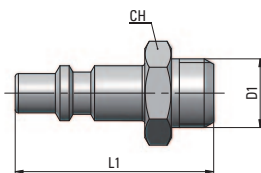

Embout mâle, profil italien

Einschraubverschlußnippel,  
italienisches Profil

Tipo	D1	L1	CH	g
20 00 14	G1/4	37,5	14	17
20 00 38	G3/8	40	19	28
20 00 12	G1/2	40,5	24	43

## GU 11-21

Innesto Italia con filetto femmina Female plug, Italian profile

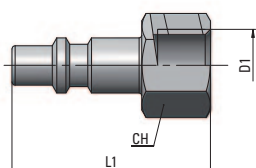

Embout femelle, profil italien

Aufschraubverschlußnippel,  
italienisches Profil

Tipo	D1	L1	CH	g
21 00 14	G1/4	39	17	23
21 00 38	G3/8	41	19	26
21 00 12	G1/2	44	25	51,1