

RA LINE

Raccordi Standard in Ottone Nichelato Brass Nickel-Plated Standard Fittings Raccords Standard en laiton nickelé Standardverschraubungen aus Messing vernickelt

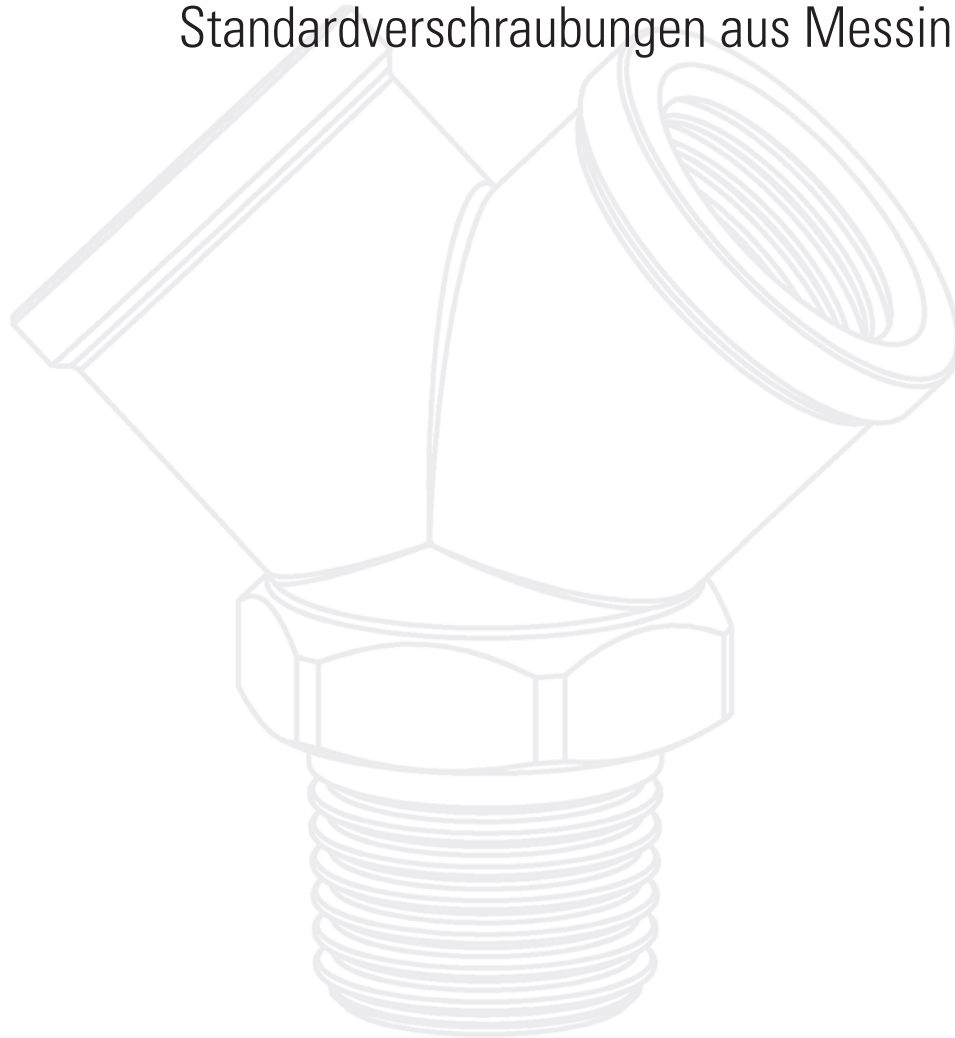

La serie RA, comunemente considerata come una serie di "Accessori" o "Raccordi Standard", è costituita da Nippli, Riduzioni, Prolunghe, Tappi, Portagomma, Raccordi a L, Raccordi a T, Croci, ecc.

Vista la varietà di funzioni ausiliarie che coprono questi raccordi, risulta evidente il ruolo di completamento, che questa serie svolge nei confronti delle altre.

Tutti i raccordi RA vengono sottoposti a trattamento superficiale di Nichelatura.

The RA line, also known as the "Accessories line" or the "Standard fittings line" consists of a wide variety of components, such as Nipples, Reduction pieces, Connections, Plugs, Hose connections, L-T and Cross fittings.

Due to the multiple auxiliary functions of this line, the RA fittings are the right complement for other ranges.

All components are brass nickel-plated.

La série RA, ou bien "La série des accessoires, ou Raccords Standard" se compose d'une grande variété de pièces pour tous raccords et toutes configurations: mamelons, pièces de réduction, bouchons, douilles cannelées, raccords en Té, en L et Croix.

Compte tenu de la variété de ses fonctions complémentaires, la principale caractéristique de cette série devient celle de bien compléter les autres gammes.

Tous les raccords de cette série sont en laiton niquelé.

Die RA Baureihe, bekannt als die "Zubehörsreihe" oder die Standardverschraubungsbaureihe" besteht aus Verschraubungen aller Bauformen und Grössen wie Nippel, Reduzierstück, Stopfen, Schlauchtüllen, T, L-Stueck, Winkel-und-Kreuzverschraubungen.

Es ist eine umfangreiche Nebenfunktionsreihe, die als Programmergänzung zu den anderen Baureihen betrachtet werden muss.

Alle Teile sind aus Messing vernickelt.

1	2
Corpo del raccordo Fitting Body Corps du raccord Verschraubungskörper	Guarnizioni Seals Joint d'étanchéité Dichtung
Ottone UNI EN 12164 CW614N - UNI EN 12165 CW617N Nichelato Brass UNI EN 12164 CW614N - UNI EN 12165 CW617N Nickel Plated Laiton UNI EN 12164 CW614N - UNI EN 12165 CW617N Nickelé Messing UNI EN 12164 CW614N - UNI EN 12165 CW617N vernickelt	NBR NBR NBR NBR

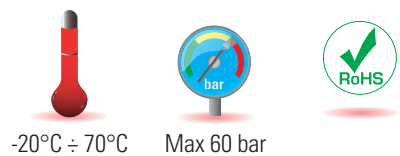

-20°C ÷ 70°C

Max 60 bar

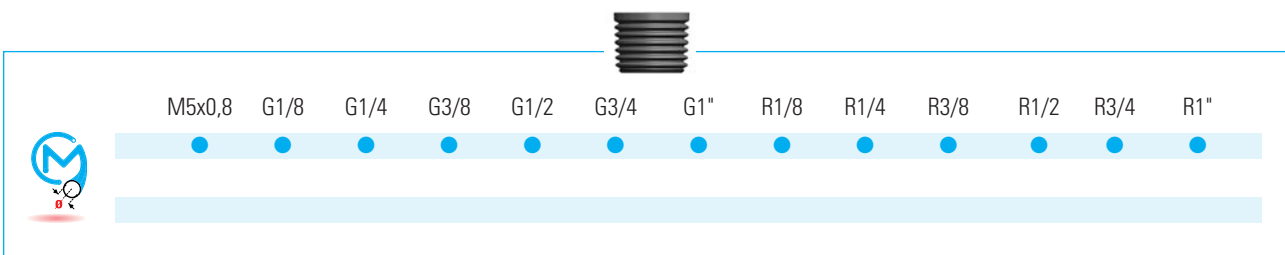
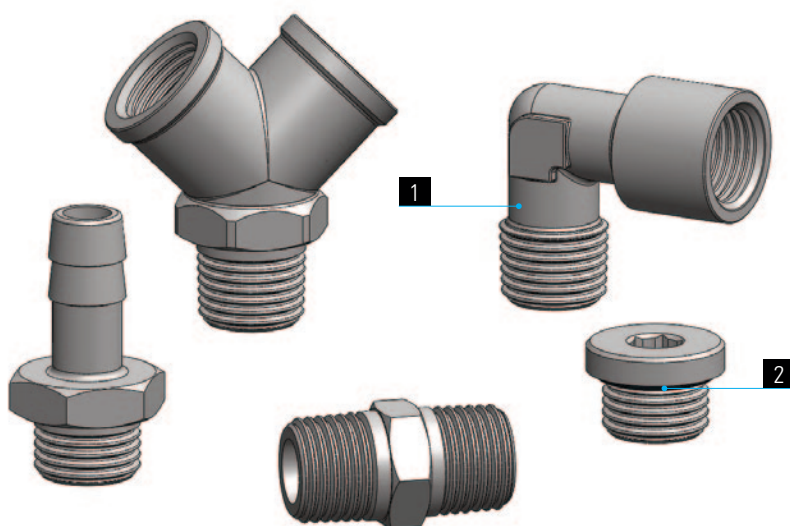

Campi di applicazione:
 Impianti pneumatici, idraulici ed oleodinamici.

Application fields:
 Pneumatic, hydraulic and oleodynamic circuits.

Domaines d'application:
 Circuits pneumatiques, hydrauliques et oléodynamiques.

Anwendungsbereiche:
 Hydraulische, öldynamische und pneumatische Anlagen.

RA 11

Niplo Cilindrico

Nipple, parallel

Mamelon cylindrique

Doppelnippel, zylindrisch

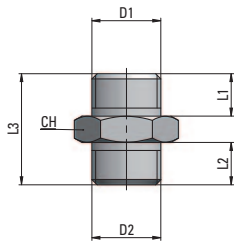

Tipo	D1	D2	L1	L2	L3	CH	g	△
11 M5 M5	M5x0,8	M5x0,8	5	5	13,5	8	2	
11 M5 18	M5x0,8	G1/8	5	6	15,5	14	8	
11 18 18	G1/8	G1/8	6	6	16,5	14	8	
11 18 14	G1/8	G1/4	6	8	19	17	14,5	
11 18 38	G1/8	G3/8	6	9	20	19	19	
11 14 14	G1/4	G1/4	8	8	21	17	16	
11 14 38	G1/4	G3/8	8	9	22	19	21	
11 14 12	G1/4	G1/2	8	10	23,5	24	32	
11 38 38	G3/8	G3/8	9	9	23	19	22	
11 38 12	G3/8	G1/2	9	10	24,5	24	35	
11 12 12	G1/2	G1/2	10	10	25,5	24	35	

RA 12

Niplo Conico

Nipple, taper

Mamelon conique

Doppelnippel, kegelig

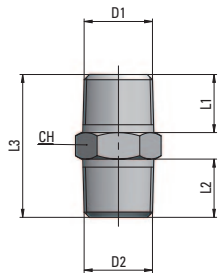

Tipo	D1	D2	L1	L2	L3	CH	g	△
12 18 18	R1/8	R1/8	7,5	7,5	20	12	8	
12 18 14	R1/8	R1/4	7,5	11	23,5	14	12	
12 18 38	R1/8	R3/8	7,5	11,5	24	17	20	
12 14 14	R1/4	R1/4	11	11	27	14	17,5	
12 14 38	R1/4	R3/8	11	11,5	27,5	17	20	
12 14 12	R1/4	R1/2	11	14	31	22	38	
12 38 38	R3/8	R3/8	11,5	11,5	28	17	23	
12 38 12	R3/8	R1/2	11,5	14	31,5	22	40	
12 12 12	R1/2	R1/2	14	14	34	22	44	
12 12 34	R1/2	R3/4	14	16,5	37,5	27	69	
12 34 34	R3/4	R3/4	16,5	16,5	40	27	78	
12 3/4 1"	R3/4	R1"	16,5	19	42,5	34	112	
12 1" 1"	R1"	R1"	19	19	45,5	34	128	

RA 13

Manicotto

Joint Piece

Manchon

Muffe

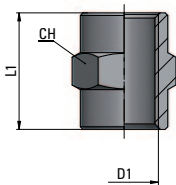

Tipo	D1	L1	CH	g	△
13 00 M5	M5x0,8	11	8	2	
13 00 18	G1/8	15	14	10,6	
13 00 14	G1/4	22	17	18,7	
13 00 38	G3/8	23	22	34,5	
13 00 12	G1/2	28	26	48,4	

RA 14

Riduzione F-M Conica

Taper Female-Male reducing connector

Réduction Femelle-Mâle, conique

Reduzierstück, Auf-Einschraub, kegelig

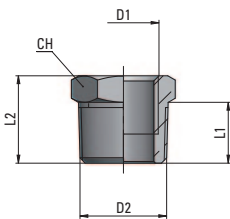

Tipo	D1	D2	L1	L2	CH	g	△
14 18 14	G1/8	R1/4	11	16	14	10,6	
14 18 38	G1/8	R3/8	11,5	16,5	17	20,7	
14 18 12	G1/8	R1/2	14	19,5	22	32,9	
14 14 38	G1/4	R3/8	11,5	16,5	17	12,6	
14 14 12	G1/4	R1/2	14	19,5	22	29,4	
14 38 12	G3/8	R1/2	14	19,5	22	23,3	
14 12 34	G1/2	R3/4	16,5	23,5	27	45	
14 12 1"	G1/2	R1"	19	27	34	132	
14 34 1"	G3/4	R1"	19	27	34	104	

RA 15

Riduzione F-M Cilindrica

Parallel Female-Male reducing connector

Réduction Femelle-Mâle, cylindrique

Reduzierstück, Auf-Einschraub, zylindrisch

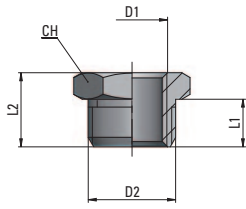

Tipo	D1	D2	L1	L2	CH	g Δ
15 M5 18	M5x0,8	G1/8	6	10,5	14	8
15 18 14	G1/8	G1/4	8	13	17	10
15 18 38	G1/8	G3/8	9	14	19	19
15 18 12	G1/8	G1/2	10	15,5	24	38
15 14 38	G1/4	G3/8	9	14	19	13
15 14 12	G1/4	G1/2	10	15,5	24	32
15 38 12	G3/8	G1/2	10	15,5	24	22

RA 16

Prolunga M-F Conica

Adaptor Male-Female, taper

Réduction Mâle-Femelle, conique

Reduziernippel, Ein-Aufschraub, kegelig

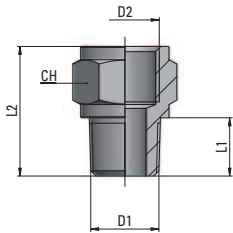

Tipo	D1	D2	L1	L2	CH	g Δ
16 18 18	R1/8	G1/8	8	18	14	13
16 18 14	R1/8	G1/4	8	21,5	17	18
16 14 14	R1/4	G1/4	11	24,5	17	22
16 14 38	R1/4	G3/8	11	25,5	22	42
16 14 12	R1/4	G1/2	11	29	24	40
16 38 38	R3/8	G3/8	11,5	26	22	42
16 38 12	R3/8	G1/2	11,5	29,5	24	40
16 12 12	R1/2	G1/2	14	32	26	57

RA 17

Prolunga M-F Cilindrica

Adaptor Male-Female, parallel

Réduction Mâle-Femelle, cylindrique

Reduziernippel, Ein-Aufschraub, zylindrisch

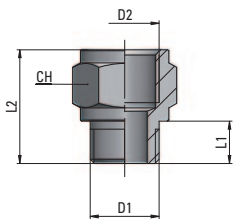

Tipo	D1	D2	L1	L2	CH	g Δ
17 M5 18	M5x0,8	G1/8	4	14,5	14	7
17 18 18	G1/8	G1/8	6	16	14	13
17 18 14	G1/8	G1/4	6	19,5	17	17
17 14 14	G1/4	G1/4	8	21,5	17	19
17 14 38	G1/4	G3/8	8	22,5	22	32
17 14 12	G1/4	G1/2	8	26	24	37
17 38 38	G3/8	G3/8	9	23,5	22	36
17 38 12	G3/8	G1/2	9	27	24	37
17 12 12	G1/2	G1/2	10	28	26	43

RA 18

Manicotto ridotto

Reduction Joint Piece

Manchon de réduction

Reduziermuffe

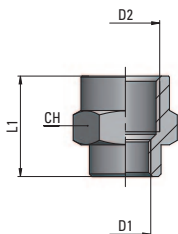

Tipo	D1	D2	L1	CH	g Δ
18 M5 18	M5x0,8	G1/8	13,5	14	10
18 18 14	G1/8	G1/4	19	17	18
18 18 38	G1/8	G3/8	20	22	36
18 14 38	G1/4	G3/8	22,5	22	41
18 14 12	G1/4	G1/2	26	24	46
18 38 12	G3/8	G1/2	26	24	46

RA 19

Tappo cilindrico

Parallel Plug

Bouchon cylindrique

Verschlussstopfen, zylindrisch

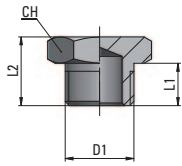

Tipo	D1	L1	L2	CH	g Δ
19 00 M5	M5x0,8	5	8,5	8	2
19 00 18	G1/8	6	10	14	7,5
19 00 14	G1/4	8	13	17	13,5
19 00 38	G3/8	9	13,5	19	18
19 00 12	G1/2	10	15,5	24	31

RA 43

Tappo Conico

Taper Plug

Bouchon cônica

Verschlussstopfen, kegelig

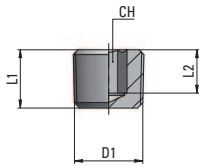

Tipo	D1	L1	L2	CH	g Δ
43 00 18	R1/8	7,5	6	5	3
43 00 14	R1/4	11	8	6	8
43 00 38	R3/8	11,5	8	10	14
43 00 12	R1/2	14	9,5	10	27
43 00 34	R3/4	15,5	10	14	52
43 00 1"	R1"	17,5	11,5	17	80

RA 20

Tappo Femmina

Female plug

Bouchon femelle

Verschlusskappe, Aufschraub

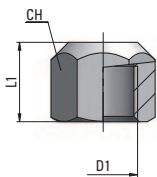

Tipo	D1	L1	CH	g Δ
20 00 18	G1/8	10	14	9,6
20 00 14	G1/4	13,5	17	16,7
20 00 38	G3/8	14	20	21,3
20 00 12	G1/2	16,5	24	31,3
20 00 34	G3/4	18,5	30	52
20 00 1"	G1"	20	38	98

RA 21

Gomito F-F

Female Elbow

Equerre Femelle

Aufschraub-Winkel

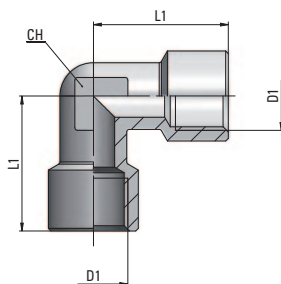

Tipo	D1	L1	CH	g Δ
21 18 18	G1/8	21	10	22
21 14 14	G1/4	25,5	13	38
21 38 38	G3/8	28	17	58
21 12 12	G1/2	33,5	21	97

RA 22

Gomito M-F

Male-Female Elbow

Equerre Mâle-Femelle

Auf-Einschraub-Winkel

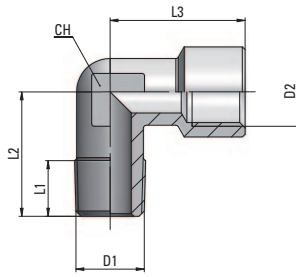

Tipo	D ₁	D ₂	L ₁	L ₂	L ₃	CH	g
22 18 18	R1/8	G1/8	8	18,5	21	10	19
22 14 14	R1/4	G1/4	11	23,5	25,5	13	35
22 38 38	R3/8	G3/8	11,5	26	28	17	50
22 12 12	R1/2	G1/2	14	31	33,5	21	87
22 34 34	R3/4	G3/4	16	33	36,5	25	126
22 1" 1"	R1"	G1"	17	39	45	30	212

RA 23

T F-F-F

Male-Female Stud Tee

Té Femelle-Mâle-Femelle

T Auf-Einschraub

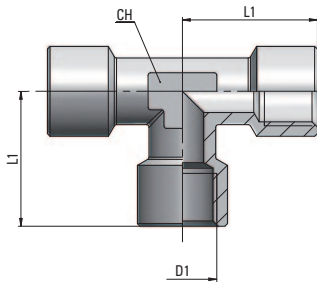

Tipo	D ₁	L ₁	CH	g
23 18 18	G1/8	21	10	29
23 14 14	G1/4	25,5	13	54
23 38 38	G3/8	28	17	82
23 12 12	G1/2	33,5	21	144

RA 24

T F-M-F

Male-Female Stud Tee

Té Femelle-Mâle-Femelle

T Auf-Einschraub

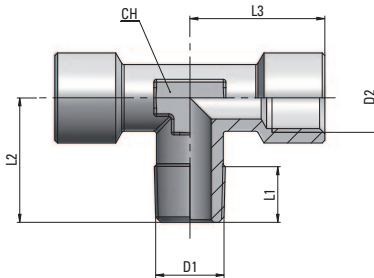

Tipo	D ₁	D ₂	L ₁	L ₂	L ₃	CH	g
24 18 18	R1/8	G1/8	8	18,5	21	10	28
24 14 14	R1/4	G1/4	11	23,5	25,5	13	48
24 38 38	R3/8	G3/8	11,5	26	28	17	74
24 12 12	R1/2	G1/2	14	31	33,5	21	122
24 34 34	R3/4	G3/4	16	33	36,5	25	178
24 1" 1"	R1"	G1"	17,5	39	45	30	304

RA 25

T M-F-F

Male-Female, Lateral Tee

Té Mâle-Femelle-Femelle

T Ein-Aufschraub

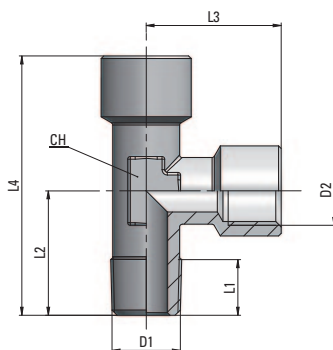

Tipo	D ₁	D ₂	L ₁	L ₂	L ₃	L ₄	CH	g
25 18 18	R1/8	G1/8	8	18,5	21	39,5	10	28
25 14 14	R1/4	G1/4	11	23,5	25,5	49	13	48
25 38 38	R3/8	G3/8	11,5	26	28	54	17	74
25 12 12	R1/2	G1/2	14	31	33,5	64,5	21	127

RA 26

Croce Femmina

Female Cross

Croix Femelle

Aufschraub-Kreuzstück

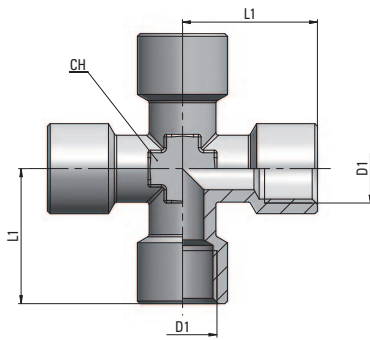

Tipo	D1	L1	CH	g
26 18 18	G1/8	21	10	41
26 14 14	G1/4	25,5	13	66
26 38 38	G3/8	28	17	112

RA 27

Gomito M-F

Male-Female Elbow

Equerre Mâle-Femelle

Auf-Einschraub-Winkel

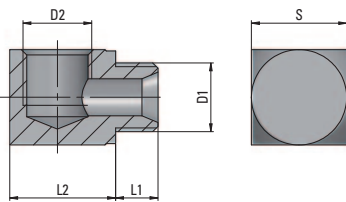

Tipo	D1	D2	L1	L2	S	g
27 M5 M5	M5x0,8	M5x0,8	5	10	9	6
27 18 18	G1/8	G1/8	6	14	13	14
27 14 14	G1/4	G1/4	8	20	18	40

RA 28

T F-M-F

Male-Female Stud Tee

Té Femelle-Mâle-Femelle

T Auf-Einschraub

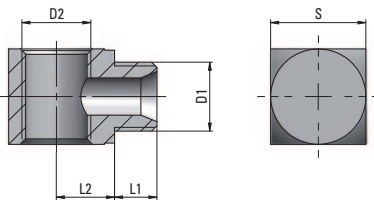

Tipo	D1	D2	L1	L2	S	g
28 M5 M5	M5x0,8	M5x0,8	5	5,5	9	5
28 18 18	G1/8	G1/8	6	7,5	13	6
28 14 14	G1/4	G1/4	8	11	18	36

RA 29

Ripartitore 4 vie

Manifold, 4 ways

Distributeur, 4 voies

Verteilblock, 4 Wege

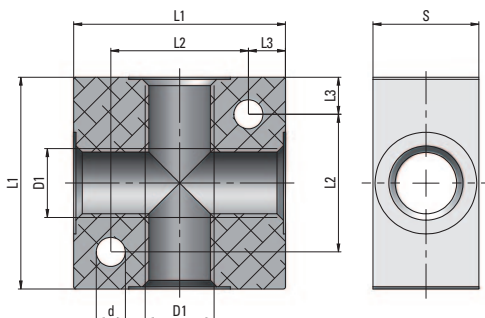

Tipo	D1	L1	L2	L3	d	S	g
29 00 M5	M5x0,8	3,2	20	14	3	10	9
29 00 18	G1/8	4,5	25	17	4	16	18
29 00 14	G1/4	5,5	40	26	7	20	64
29 00 38	G3/8	5,5	50	34	8	25	125
29 00 12	G1/2	5,5	50	34	8	30	138

RA 29 S

Ripartitore Singolo

Manifold, Single

Distributer, simple

Verteilblock, einfach

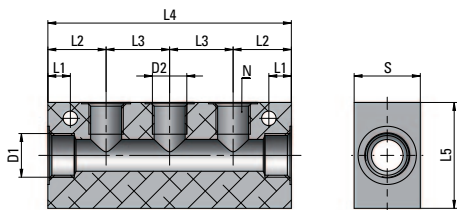

Tipo	D1	D2	N	L1	L2	L3	L4	L5	s	g Δ
29 14 18 S3	G1/4	G1/8	3	4,5	18	18	72	30	20	86
29 14 18 S4	G1/4	G1/8	4	4,5	18	18	90	30	20	110
29 14 18 S5	G1/4	G1/8	5	4,5	18	18	108	30	20	130
29 38 14 S3	G3/8	G1/4	3	8,5	22	24	92	40	25	184
29 38 14 S4	G3/8	G1/4	4	8,5	22	24	116	40	25	238
29 38 14 S5	G3/8	G1/4	5	8,5	22	24	140	40	25	298

Corpo in Alluminio Non Ossidato - Alu body, not anodized - Corps Alu, non anodisé - Alukörper, nicht eloxiert

RA 29 D

Ripartitore Doppio

Manifold, Double

Distributeur, double

Verteilblock, zweifach

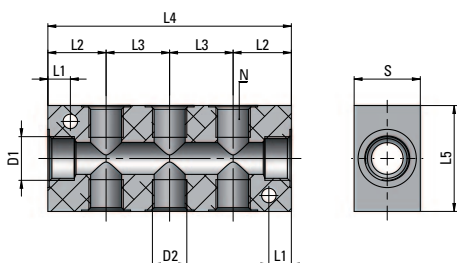

Tipo	D1	D2	N	L1	L2	L3	L4	L5	s	g Δ
29 14 18 D3	G1/4	G1/8	3+3	4,5	18	18	72	30	20	81
29 14 18 D4	G1/4	G1/8	4+4	4,5	18	18	90	30	20	100
29 14 18 D5	G1/4	G1/8	5+5	4,5	18	18	108	30	20	122
29 38 14 D3	G3/8	G1/4	3+3	8,5	22	24	92	40	25	170
29 38 14 D4	G3/8	G1/4	4+4	8,5	22	24	116	40	25	216
29 38 14 D5	G3/8	G1/4	5+5	8,5	22	24	140	40	25	266

Corpo in Alluminio Non Ossidato - Alu body, not anodized - Corps Alu, non anodisé - Alukörper, nicht eloxiert

RA 30

Portagomma

Hose Connector

Douille cannelée

Schlauchtülle

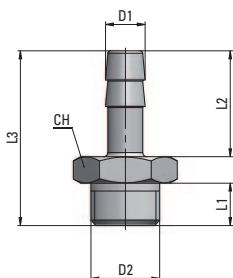

Tipo	D1	D2	L1	L2	L3	CH	g Δ
30 03 M5	3	M5x0,8	5	9	17	8	2
30 3,5 M5	3,5	M5x0,8	5	9	17	8	2
30 4,5 M5	4,5	M5x0,8	5	9	17	8	2
30 7,5 18	7,5	G1/8	6	20	30	14	10,5
30 7,5 14	7,5	G1/4	8	20	33	17	17
30 8,5 18	8,5	G1/8	6	20	30	14	11,5
30 9,5 18	9,5	G1/8	6	20	30	14	11
30 9,5 14	9,5	G1/4	8	20	33	17	18
30 9,5 38	9,5	G3/8	9	20	34	19	22
30 12,5 14	12,5	G1/4	8	22	33	17	21
30 12,5 38	12,5	G3/8	9	22	34	19	24
30 12,5 12	12,5	G1/2	10	22	38	24	38
30 17,5 38	17,5	G3/8	9	24	38	19	38
30 17,5 12	17,5	G1/2	10	24	39,5	24	43

RA 31

Dado

Nut

Ecrou

Überwurfmutter

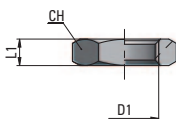

Tipo	D1	L1	CH	g Δ
31 00 18	G1/8	4,5	14	4
31 00 14	G1/4	5	17	5
31 00 38	G3/8	5,5	19	5
31 00 12	G1/2	6	24	8
31 00 M10x1	M10x1	4	14	3
31 00 M12x1	M12x1	5	16	5
31 00 M14x1	M14x1	5	18	5,5
31 00 M16x1	M16x1	5	20	6
31 00 M20x1,5	M20x1,5	4	27	10,5

RA 35

Gomito M-M

Male-Male Elbow

Equerre Mâle

Einschraub-Winkelstück

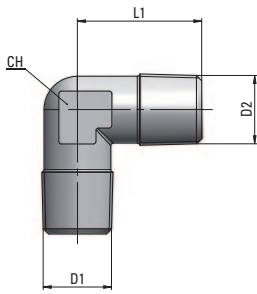

Tipo	D1	D2	L1	CH	g Δ
35 18 18	R1/8	R1/8	18,5	10	13
35 14 14	R1/4	R1/4	23,5	13	27
35 38 38	R3/8	R3/8	26	17	41
35 12 12	R1/2	R1/2	31	21	71
35 34 34	R3/4	R3/4	33	25	100
35 1" 1"	R1"	R1"	39	30	174

RA 36

T M-M-M

Male Tee

Té Mâle

Einschraub-T-Stück

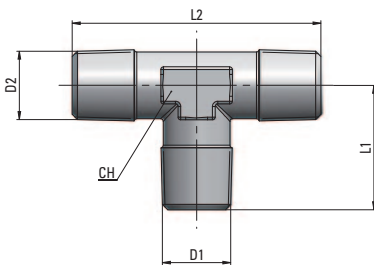

Tipo	D1	D2	L1	L2	CH	g Δ
36 18 18	R1/8	R1/8	18,5	37	10	15
36 14 14	R1/4	R1/4	23,5	47	13	39
36 38 38	R3/8	R3/8	26	52	17	56
36 12 12	R1/2	R1/2	31	62	21	93
36 34 34	R3/4	R3/4	33	66,4	25	134
36 1" 1"	R1"	R1"	39	79	30	236

RA 38

Riduzione a Gomito M-M

Elbow reduction Male-Male

Réduction équerre, Mâle-Mâle

Einschraub-Reduzierstück

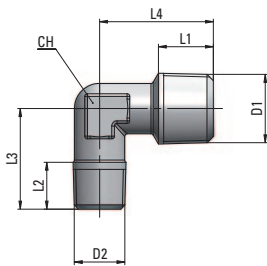

Tipo	D1	D2	L1	L2	L3	L4	CH	g Δ
38 18 14	R1/4	R1/8	11	8	19	21,5	10	17

RA 39

Prolunga M-F

Extention Male-Female

Prolongation Mâle-Femelle

Verlängerung M-F

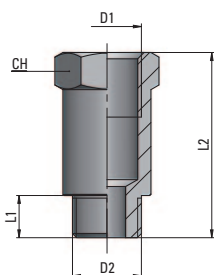

Tipo	D1	D2	L1	L2	CH	g Δ
39 18 22	G1/8	G1/8	6	22	14	15
39 18 42	G1/8	G1/8	6	42	14	30
39 14 35	G1/4	G1/4	8	35	17	32
39 14 51	G1/4	G1/4	8	51	17	46

RA 40

Y F-F-F

Female Y

Y avec filéage intérieur

Y mit Innengewinde

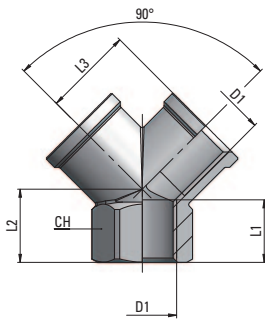

Tipo	D1	L1	L2	L3	CH	g Δ
40 00 18	G1/8	8	12	14	13	18
40 00 14	G1/4	11	14	17	17	33
40 00 38	G3/8	11,5	16	19	20	44
40 00 12	G1/2	14	19	24,5	25	93

RA 41

Y M-F-F

Male Female Y

Y avec filéage intérieur/extérieur

Y mit Innen-Aussengewinde

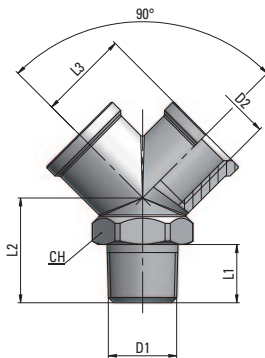

Tipo	D1	D2	L1	L2	L3	CH	g Δ
41 00 18	R1/8	G1/8	8	16	14	13	22
41 00 14	R1/4	G1/4	11	20	17	17	38
41 00 38	R3/8	G3/8	11,5	22	19	20	53
41 00 12	R1/2	G1/2	14	27	24,5	25	108

RA 42

Anello filettato

Single Banjo Ring

Bague orientable simple

Einfaches Schwenkringstück

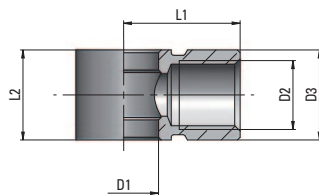

Tipo	D1	D2	D3	L1	L2	g Δ
42 00 M5	5,1	M5x0,8	9	11,5	10	7
42 00 M5 /R	7	M5x0,8	9	11,5	10	6
42 00 18	10	G1/8	14	16	15	15
42 00 14	13,2	G1/4	17	22	17	25
42 00 38	17	G3/8	20	26	20	40
42 00 12	21	G1/2	26	32	24	66

/R = Solo per regolatori di flusso - For flow controls only- Seulement pour les réducteurs de débit - Nur für Drosselrückschlagventil

RA 44

Passaparete Filettato

Bulkhead Connector

Traversée en cloison

Schottverschraubung

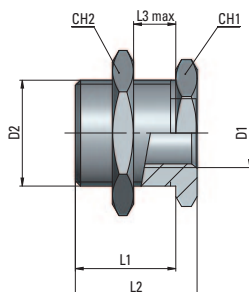

Tipo	D1	D2	L1	L2	L3max	CH1	CH2	g Δ
44 00 M5	M5x0,5	M10x1	10,5	14	7	14	14	12
44 00 18	G1/8	M16x1,5	14	18	8	19	22	29
44 00 14	G1/4	M20x1,5	20	24	13	24	27	48
44 00 38	G3/8	M26x1,5	21	26	13	30	32	91
44 00 12	G1/2	M28x1,5	27	33	19	32	36	112

RA 45

T M-F-M

Male-Female-Male Tee

Té Mâle-Femelle-Mâle

T, Ein-Aufschraub

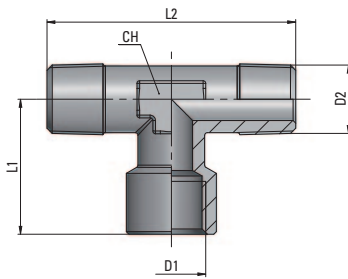

Tipo	D1	D2	L1	L2	CH	g Δ
45 18 18	G1/8	R1/8	21	37	10	25
45 14 14	G1/4	R1/4	25,5	47	13	44
45 38 38	G3/8	R3/8	28	52	17	64

RA 46

Tappo Maschio con Oring

Male Plug with Oring

Bouchon Mâle avec Oring

Einschraubstopfen mit Oring

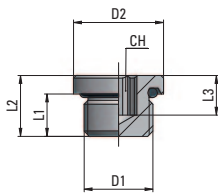

Tipo	D1	D2	L1	L2	L3	CH	g Δ
46 00 18	G1/8	14	6,5	9,5	5,5	5	5,5
46 00 14	G1/4	17	8	11,5	6,5	6	11
46 00 38	G3/8	20	9	12,5	6	8	18,5
46 00 12	G1/2	26	10	14	7	10	33

RA 94

Rondella in Plastica PA6

PA6 Sealing Ring

Bague étanchéité en PA6

PA6 Dichtring

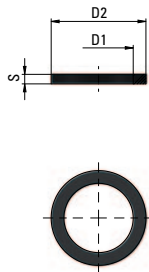

Tipo	D1	D2	S	g Δ
94 00 M5	5	8	1,2	0,08
94 00 18	9,9	13,9	1,8	0,19
94 00 14	13,1	17,9	1,8	0,28
94 00 38	16,8	21,4	1,8	0,31
94 00 12	21	25,4	2	0,42

RA 95

Rondella in Plastica PA6,
imperdibile

PA6 Toothed Sealing Ring

Bague étanchéité en PA6,
imperdable

PA6 Dichtring, unverlierbar

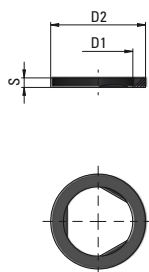

Tipo	D1	D2	S	g Δ
95 00 M5	5	8	1,2	0,08
95 00 18	9,9	13,9	1,8	0,19
95 00 14	13,1	17,9	1,8	0,28
95 00 38	16,8	21,4	1,8	0,31
95 00 12	21	25,4	2	0,42

RA 96

Rondella di tenuta in Alluminio

Aluminium Sealing Washer

Bague étanchéité en aluminium

Aluminiumdichtring

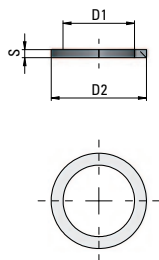

Tipo	D1	D2	S	\varnothing Δ
96 00 M5	5,2	9	1	0,1
96 00 18	10,3	14	1,5	0,25
96 00 14	13,5	18	1,5	0,42
96 00 38	17	22	1,5	0,54
96 00 12	21,5	27	1,5	0,77

RA 97

Rondella di tenuta in PTFE

PTFE Sealing Ring

Bague étanchéité en PTFE

PTFE Dichtring

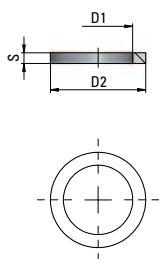

Tipo	D1	D2	S	\varnothing Δ
97 00 18	9,9	14	2	0,25
97 00 14	13,1	18	2	0,42
97 00 38	16,8	21,5	2	0,58
97 00 12	21	25,5	2	0,75

RA 98

Rondella di tenuta Acciaio/NBR

Bonded Seal

Bagues BS

Stahldichtringe mit NBR Einlage

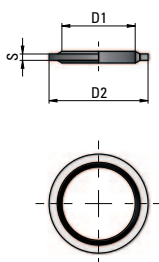

Tipo	D1	D2	S	\varnothing Δ
98 00 18	10,4	14,7	1,2	0,6
98 00 14	13,85	18,7	1,2	0,77
98 00 38	17,35	22,7	1,2	1,10
98 00 12	21,65	26,7	1,2	1,20
98 00 34	27,3	32,6	1,2	1,50

RA 99

Rondella di tenuta Acciaio/NBR
con autocentraggio

Bonded Seal, self centring

Bagues BS avec auto centrage

Stahldichtringe mit NBR Einlage,
selbstzentrierend

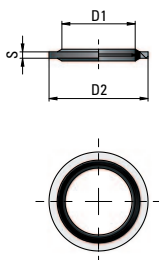

Tipo	D1	D2	S	\varnothing Δ
99 00 M5	5,7	9	1	0,24
99 00 18	10,37	15,88	2	1,59
99 00 14	13,74	20,57	2	2,66
99 00 38	17,28	23,80	2	3
99 00 12	21,54	28,58	2,5	4,57
99 00 34	27,05	34,93	2,5	6,80

RA 33

Pistole per Aria

Max Pressione di lavoro 6 bar
Temperatura d'esercizio: -10 ÷ +70 °C
Filettatura di connessione: G 1/4

Air Blow Gun

Max Working Pressure 6 bar
Working Temperature: -10 ÷ +70 °C
Connection Thread: G 1/4

Soufflettes

Max pression d'emploi 6 bar
Température de service: -10 ÷ +70 °C
Filetage de connexion: G 1/4

Ausblaspistole

Max Druckbereich 6 bar
Betriebstemperatur: -10 ÷ +70 °C
Anschlussgewinde: G 1/4

Corpo Body Corps Körper	Molla Spring Ressort Feder	Guarnizioni Seals Joint d'étanchéité Dichtung	Tubetto Tube Tube Rohr	Tipo	dB (6 bar)	g 
POM	Acciaio Inox Stainless Steel Acier Inox Edelstahl	NBR	Ottone Nichelato Brass Nickel Plated Laiton Nickelé Messing ver- nickelt	33 SL	75,1	98
				33 130	79,5	112
				33 350	79,2	146

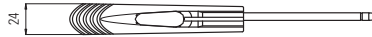
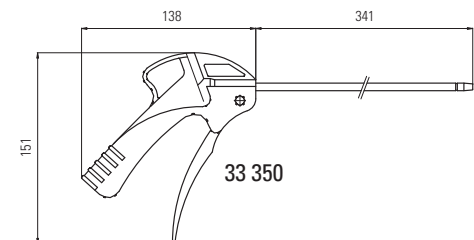
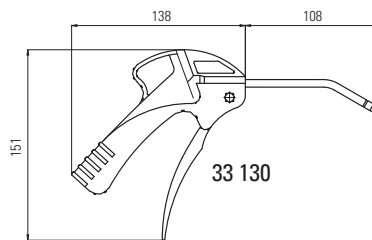
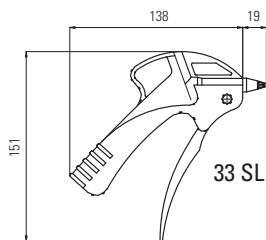

RA 34

Pinza Taglia Tubo

Hose Cutter

Coupe Tube

Schlauchsneider

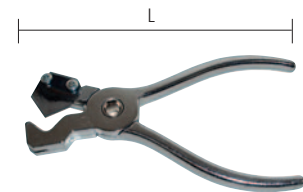

Tipo	Øe Tubo	L	g 
34 12	da ø 2 a ø 12	130	99,5
34 25	da ø 12 a ø 25	185	293

RA 37

Lame di ricambio per pinze

Spare Blades

Lame

Ersatzklingen



Tipo	Øe Tubo	g 
37 12	da ø 2 a ø 12	2
37 25	da ø 12 a ø 25	6,5