

Złącza WTYKOWE do przewodów z tworzyw sztucznych
Materiał: MOSIADZ NIKLOWANY

Złącza WTYKOWE do przewodów z tworzyw sztucznych
Materiał: TWORZYWO SZTUCZNE - POLIMER

Złącza WTYKOWE do przewodów z tworzyw sztucznych
Materiał: STAL NIERDZEWNA

Złącza GWINTOWANE PRZEWODY pneumatyczne, OSPRZĘT
Materiał: złącza: MOSIADZ NIKLOWANY
Przewody: POLIAMID, POLIETYLEN, POLIURETAN, TEFLON

Złącza ZAKRĘCANE do przewodów z tworzyw sztucznych
Materiał: MOSIADZ NIKLOWANY

SERIE MA

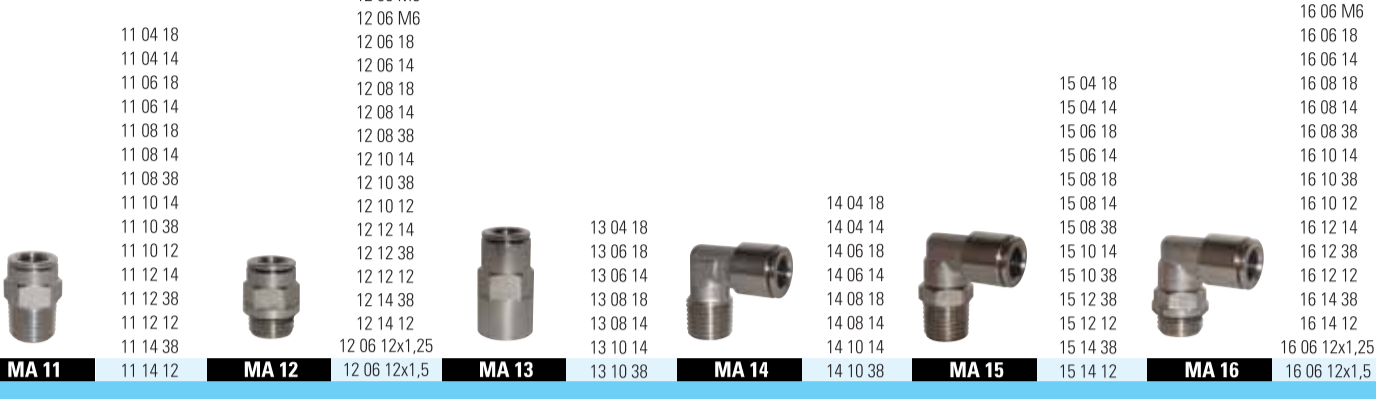

SERIE MB

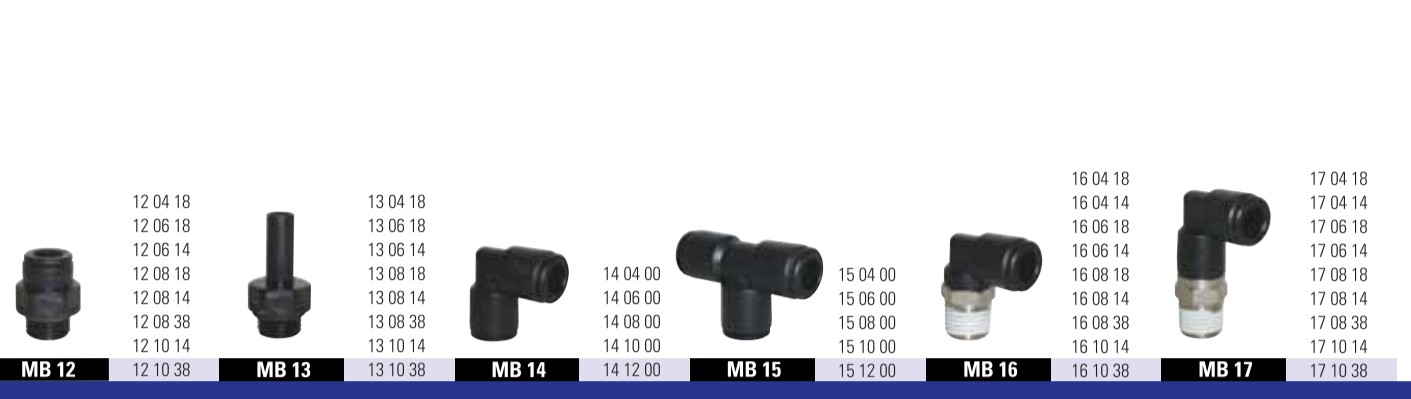

SERIE MX

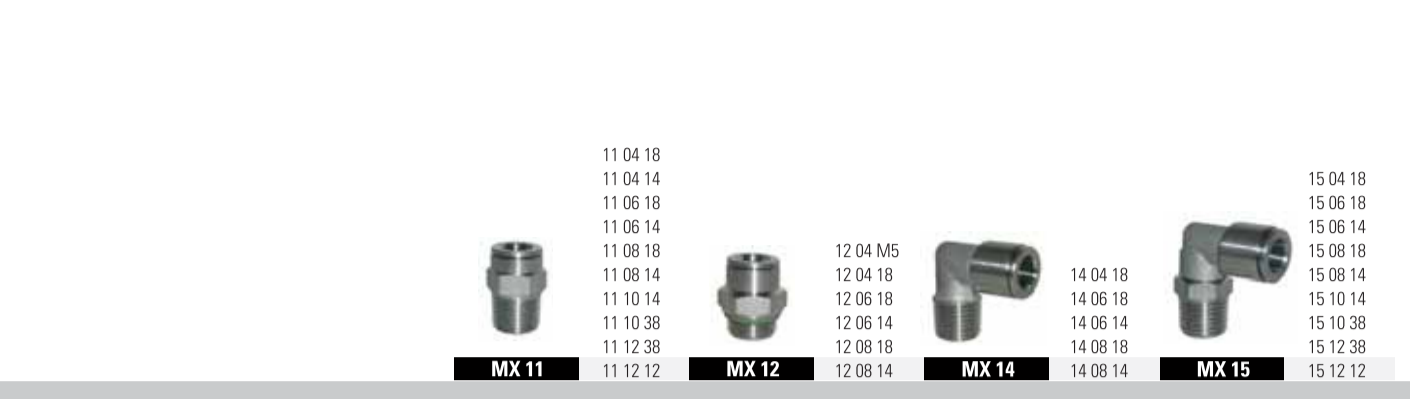

SERIE RA



SERIE MC

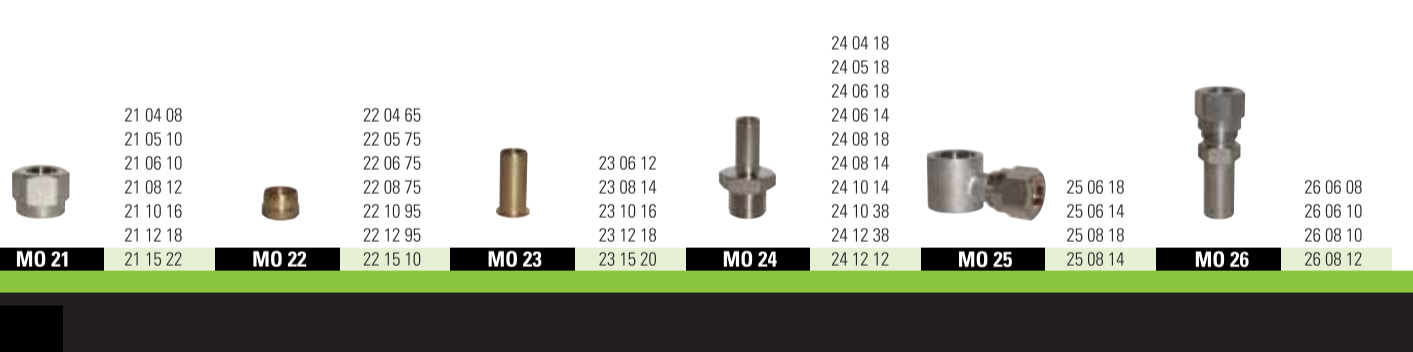
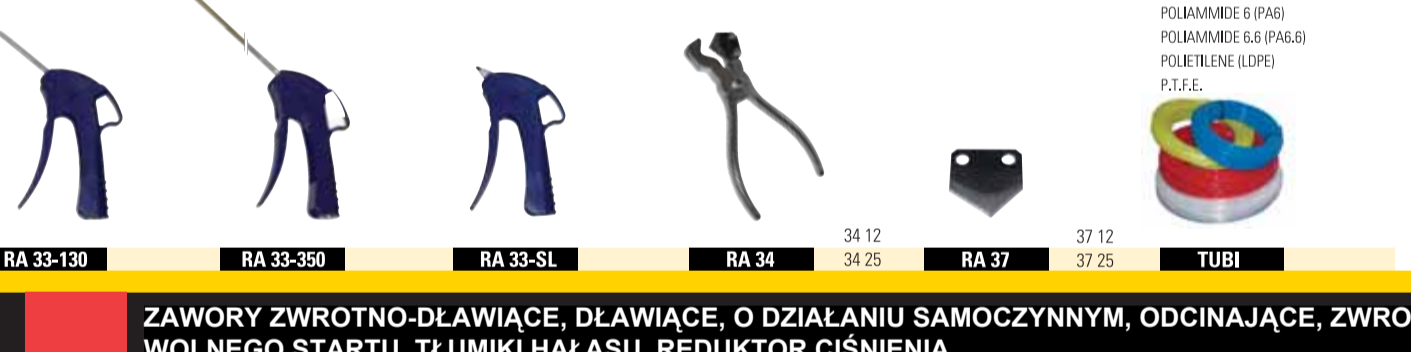
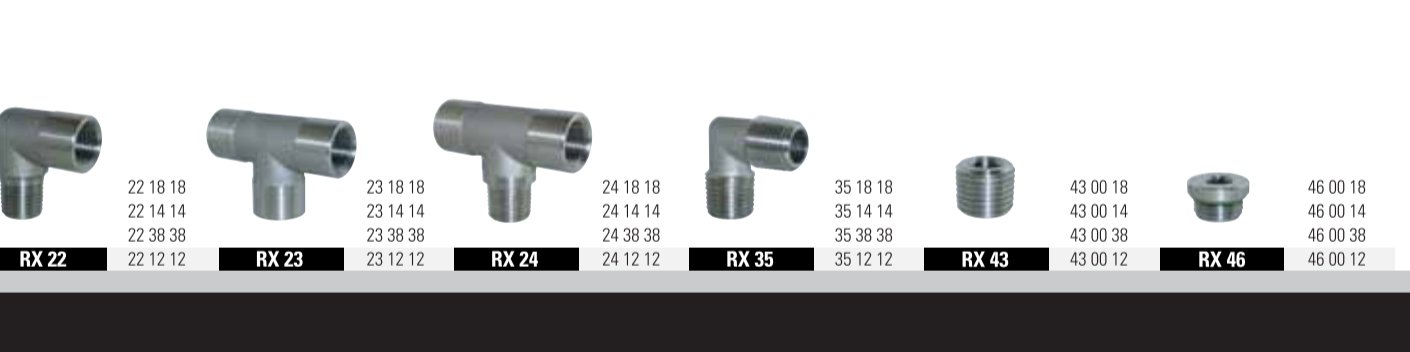
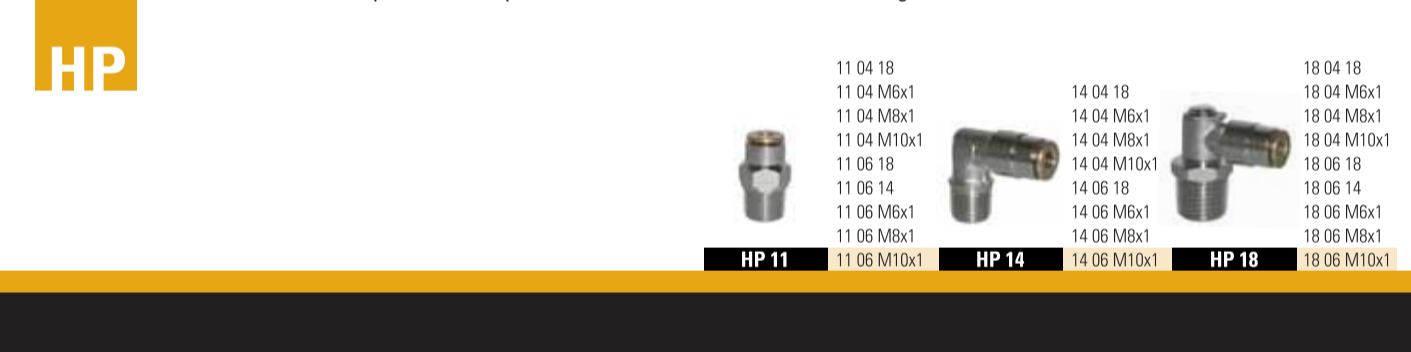
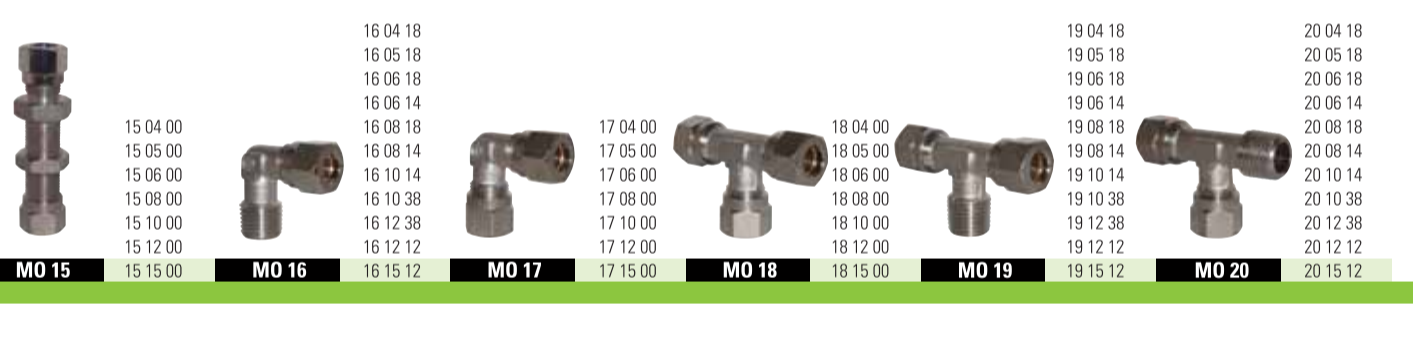
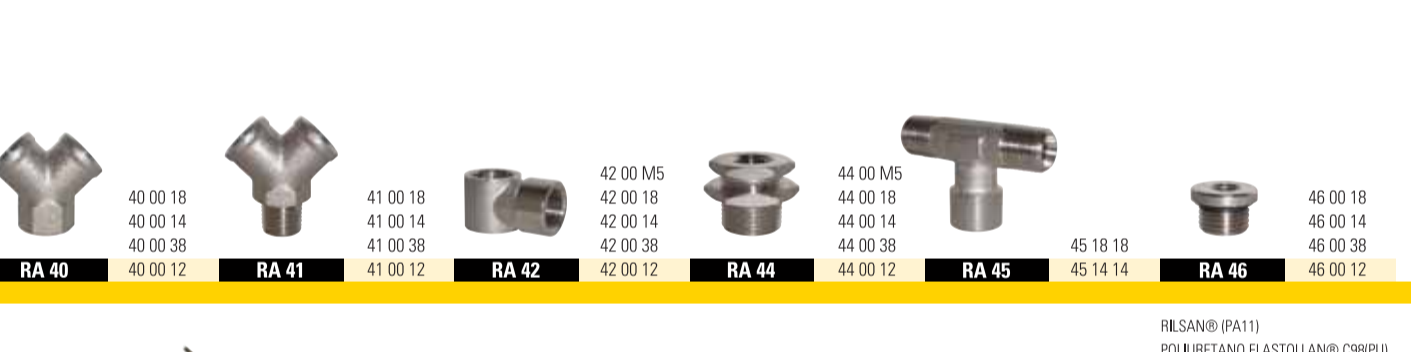
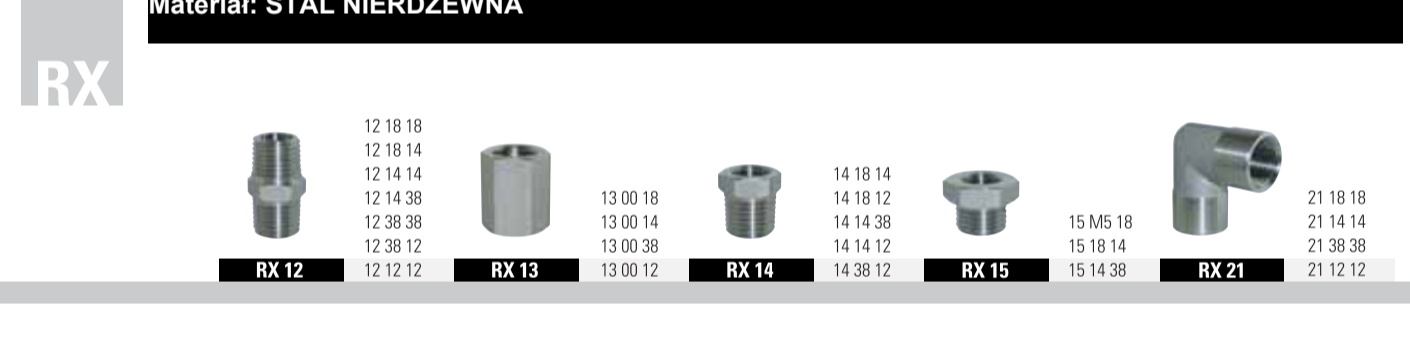
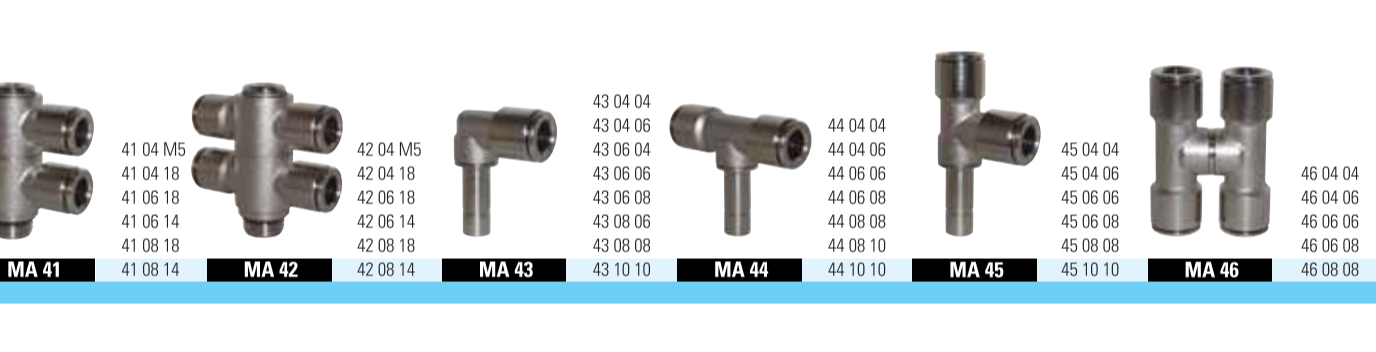
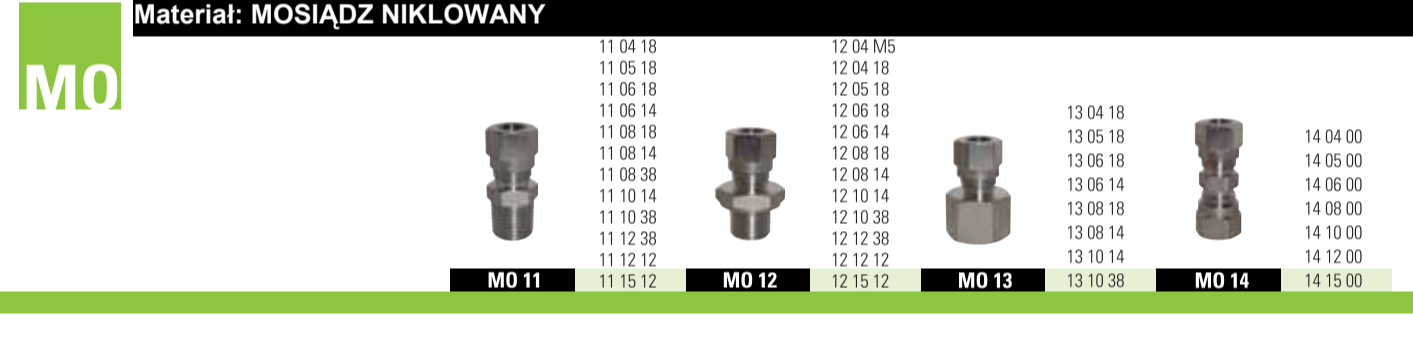
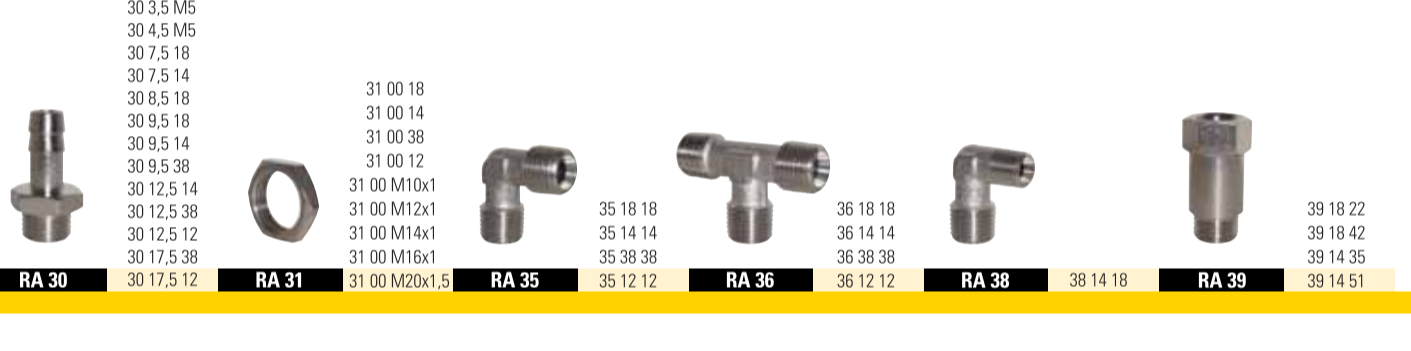
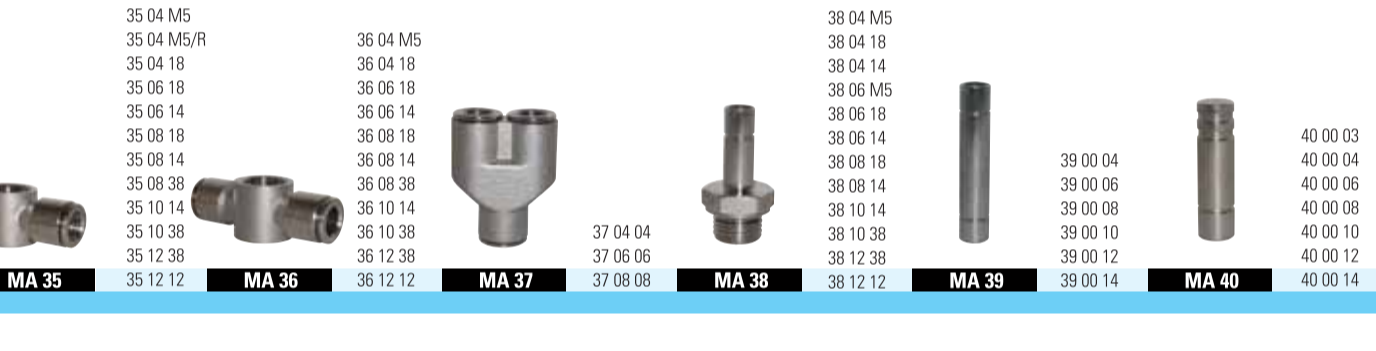
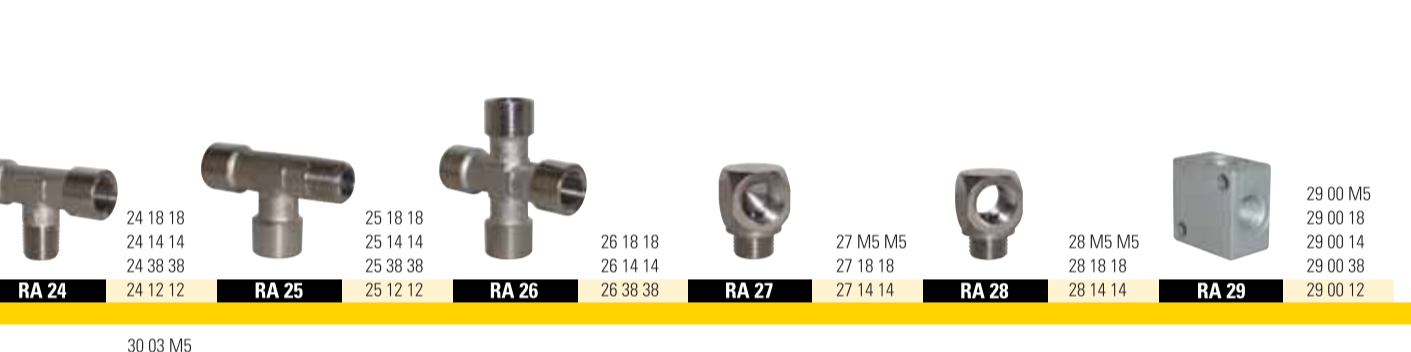
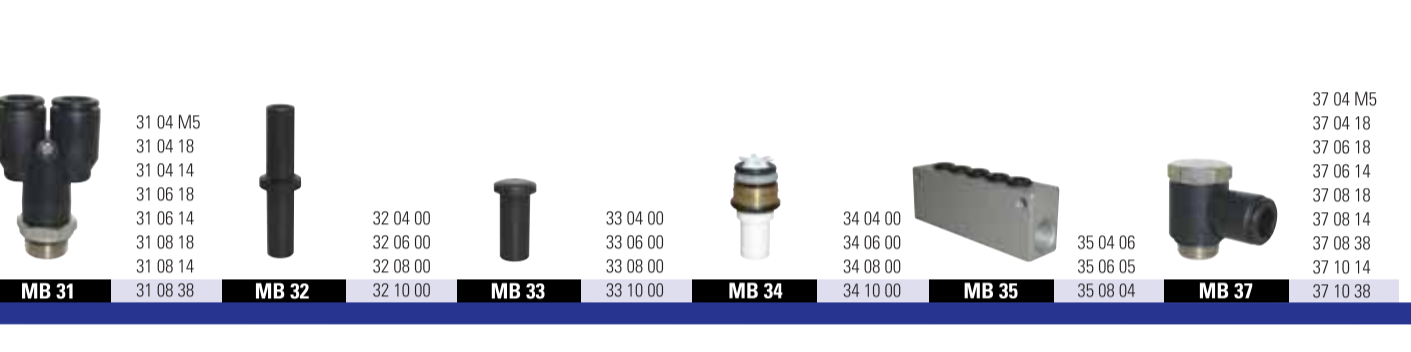
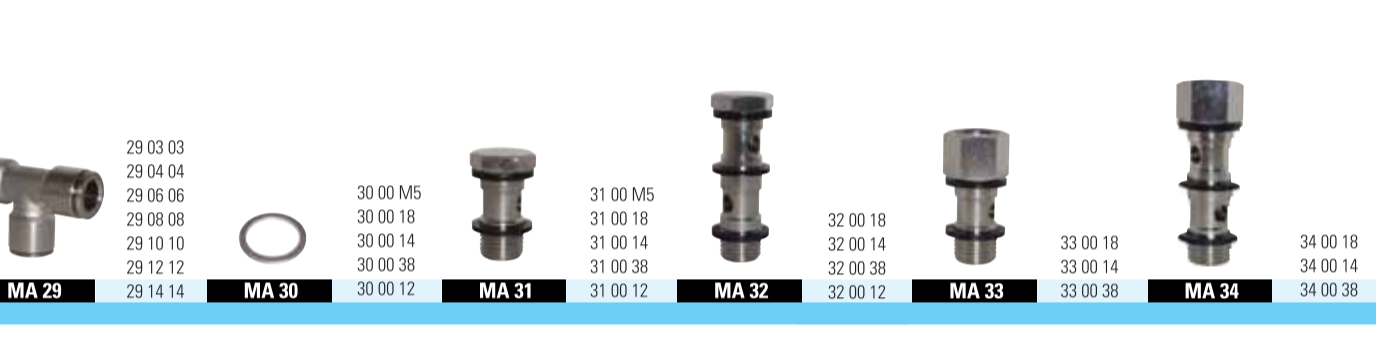
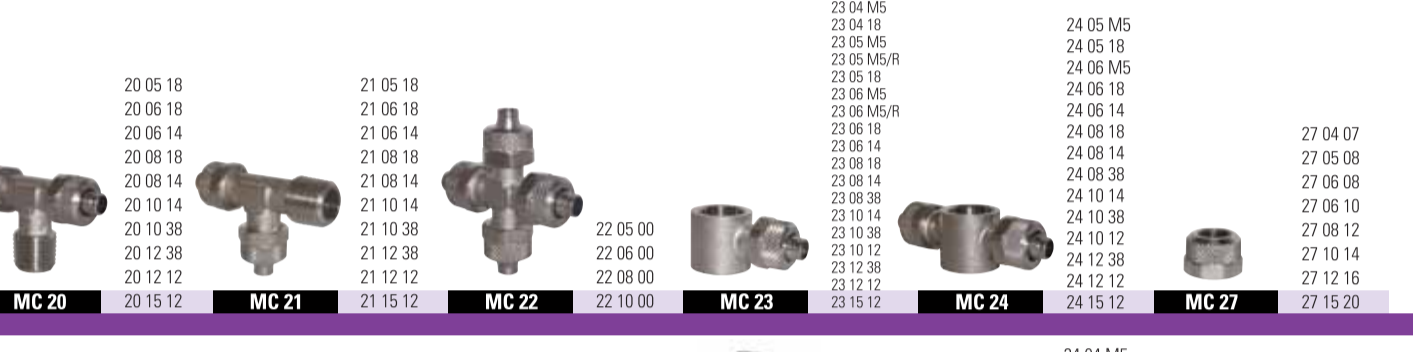
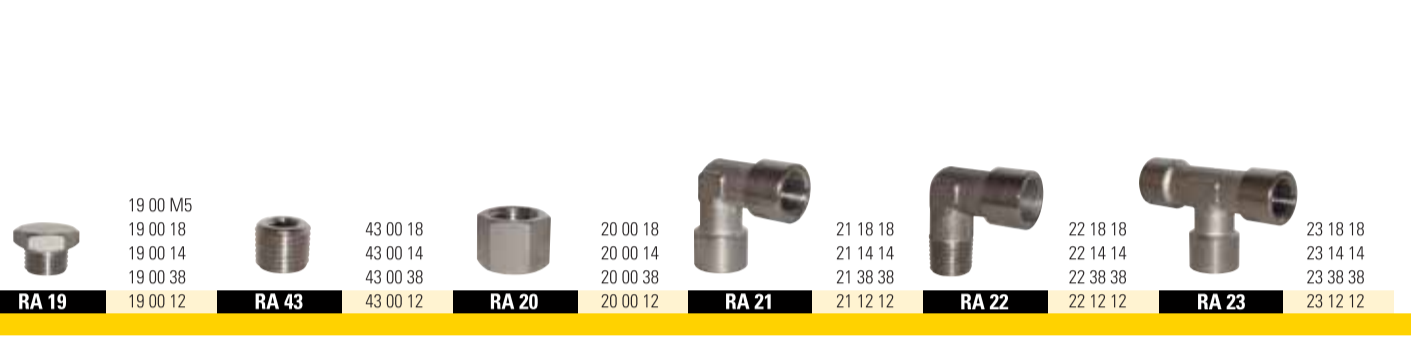
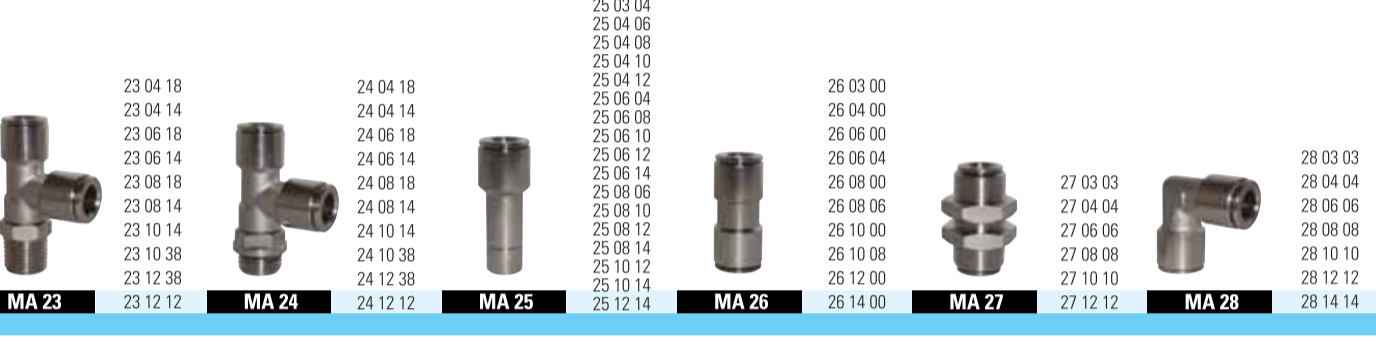
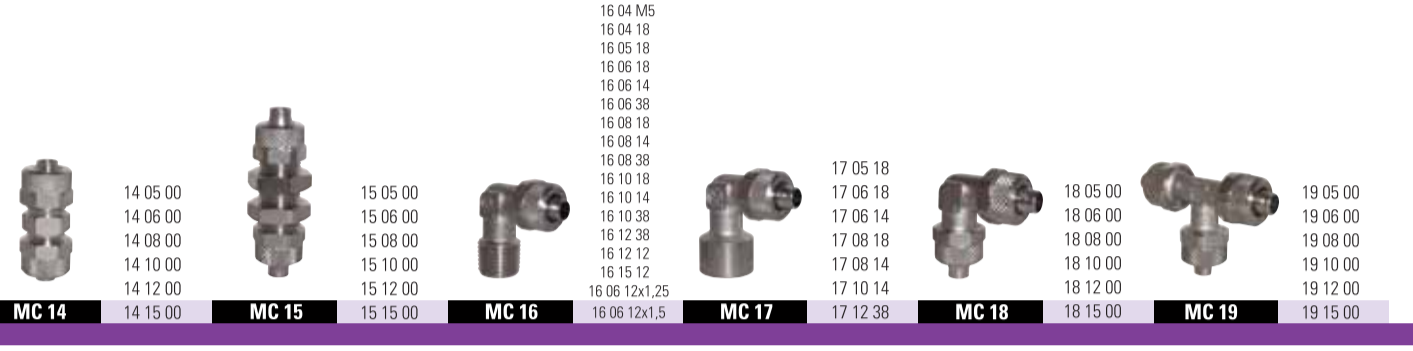
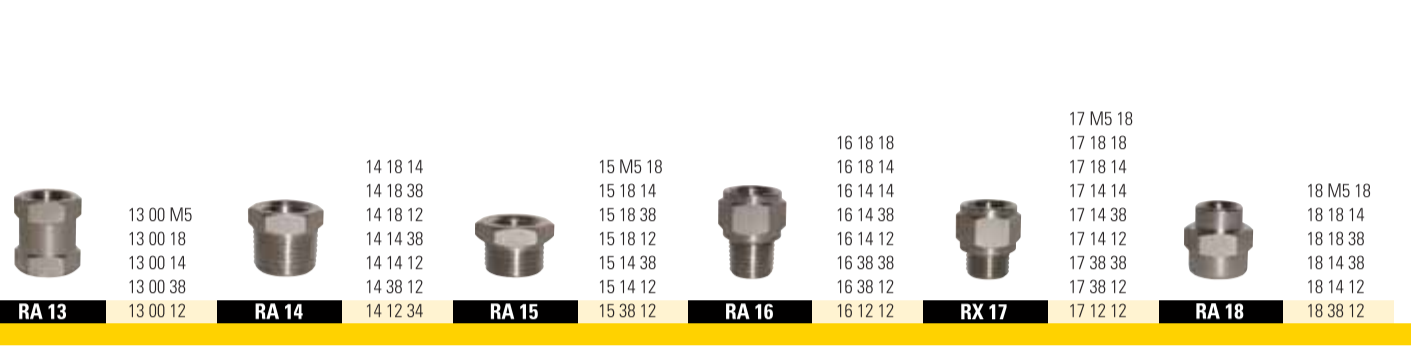
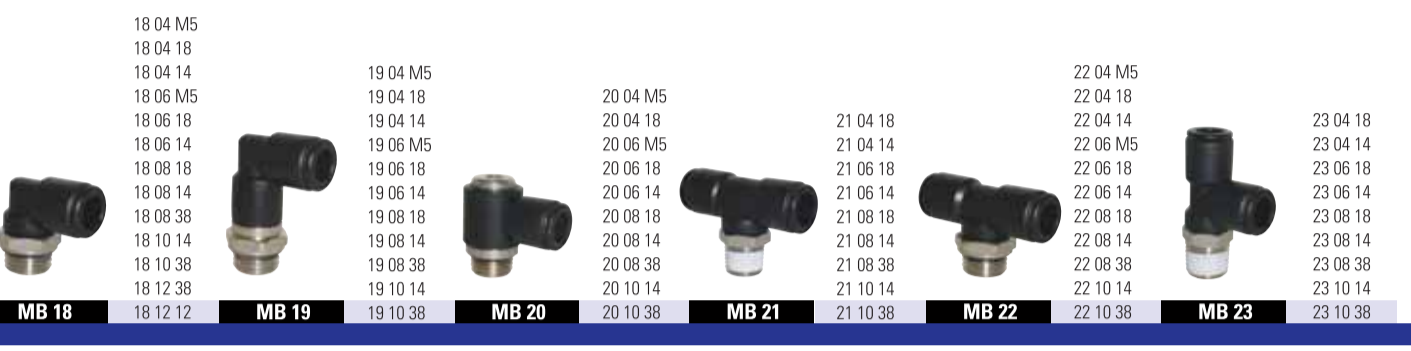
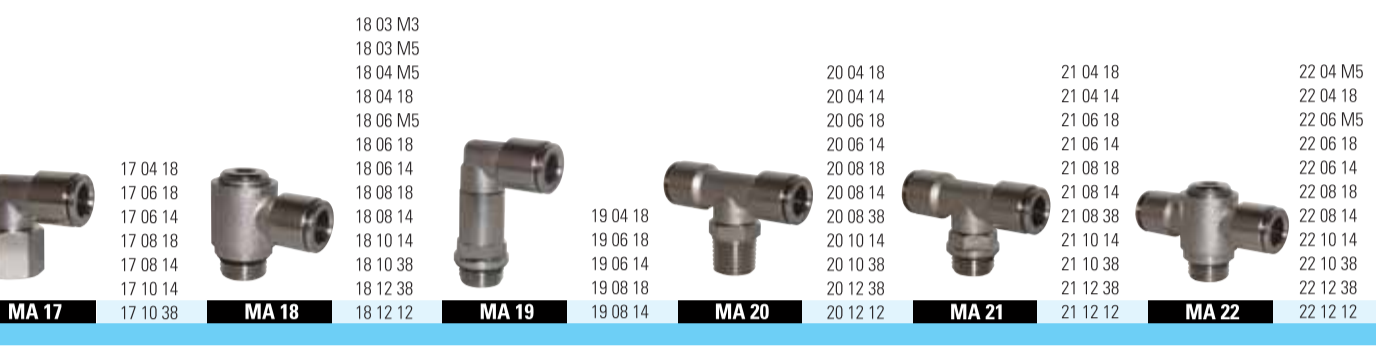
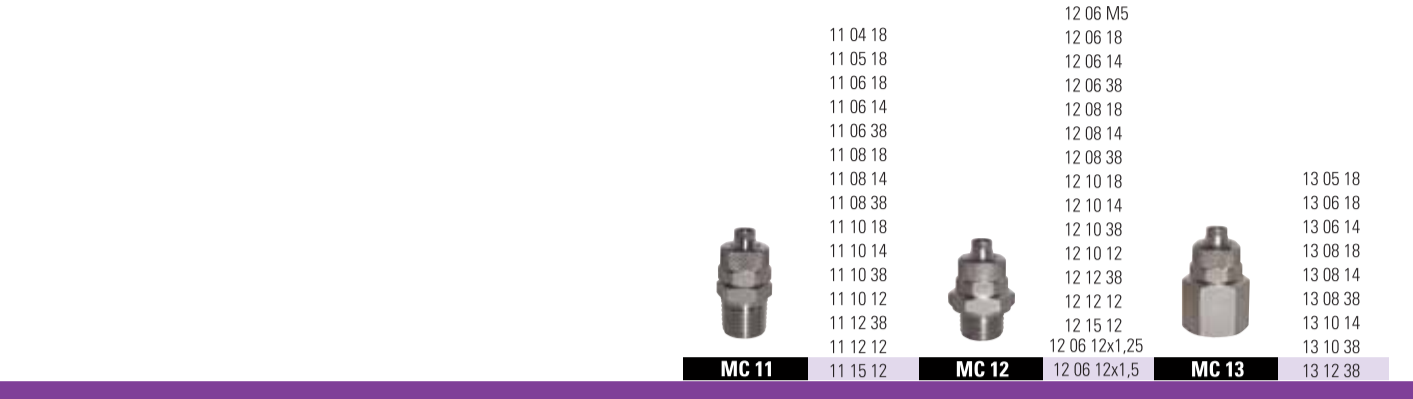

SZYBKOZŁĄCZA pneumatyczne, JEDNOSTRONNIE ODCINAJĄCE, Złącza WTYKOWE
Materiał: MOSIADZ NIKLOWANY

ZAWORY ZWROTNO-DŁAWIĄCE, DŁAWIĄCE, O DZIAŁANIU SAMOCZYNNYM, ODCINAJĄCE, ZWROTNE,
WOLNEGO STARTU, TŁUMIKI HAŁASU, REDUKTOR CIŚNIENIA

SERIE GU

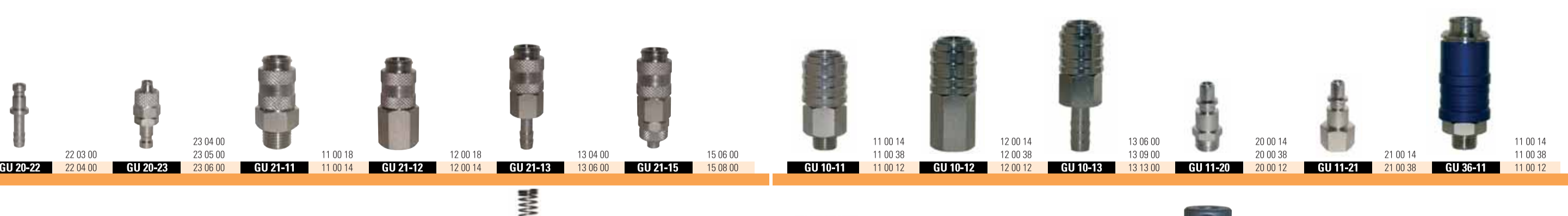
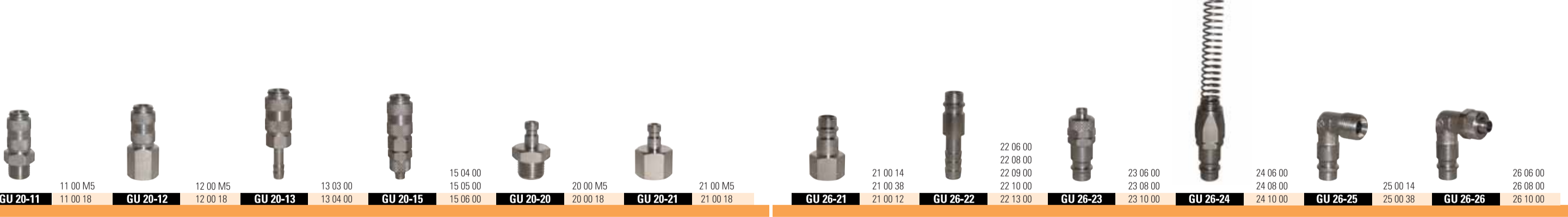

www.pneumatyka.org

ELEKTRO-AUTOMATIC pneumatic components

Elektron-AUTOMATIC 05-820 Piastów k/W-yy ul. Orzeszkowej 64 tel./fax 22 723-15-43 tel. 22 753-94-79

e-mail: biuro@pneumatyka.org www.pneumatyka.org



KONTROLA - JAKOŚĆ - ELASTYCZNOŚĆ - BEZPIECZEŃSTWO

www.cmatic.it

C.MATIC via Donizetti, 76 20048 Carate Sza (MI) ITALY

SERIE MV

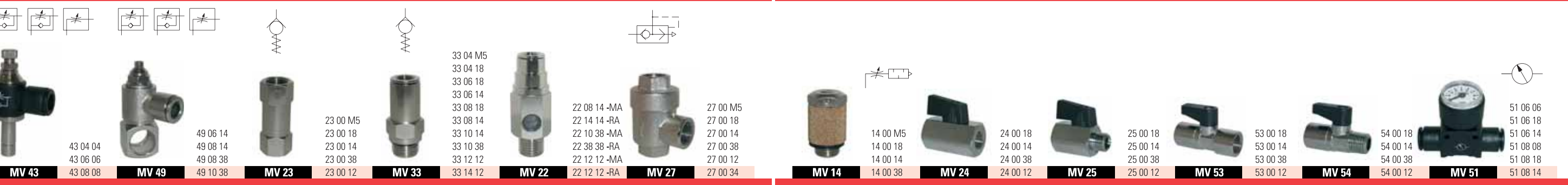
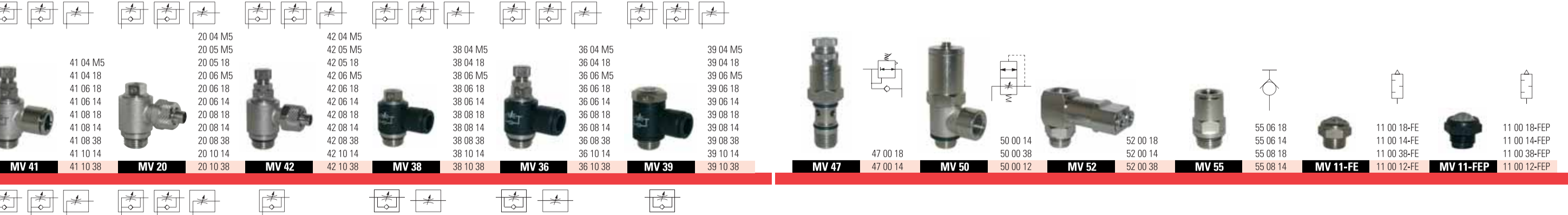
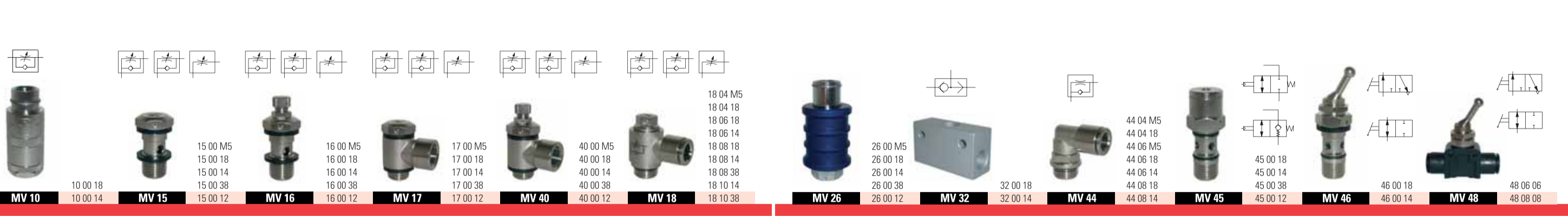

C.MATIC via Donizetti, 76 20048 Carate Sza (MI) ITALY tel. +39 0362 805246 fax +39 0362 805262 e-mail: cmatic@cmatic.it